

Stream Stabilization Plan



EXISTING CONDITIONS



Fluvial bank erosion is caused by water in the stream moving past the streambanks. The shear stress caused by the flow entrains soil particles into the flow, causing the stream bank to erode away. This is the most common type of erosion that occurs in streams. Virtually all streams experience this type of erosion as their flow path evolves over time. However, the rate of fluvial bank erosion can increase when the stream is out of equilibrium with its watershed. Increased flow from a watershed will increase the rate of fluvial bank erosion. In many cases, it appears to be a part of the natural process of stream evolution. In places where the channel is confined by the valley walls, however, fluvial bank erosion can lead to failure of the high banks. It can also undermine storm sewer inlets.

Stone Toe Protection is constructed from cobble-sized rock on the creek edges. It extends to approximately the bankfull level, which will protect the channel banks for flow events that occur every 1 to 2 years or less. The material will extend into the ground to resist scour. Coarse gravel is used to separate the larger rock material from underlying soil. Stone toe protection is typically used in conjunction with revegetation of the upper banks.

SECTION RENDERING

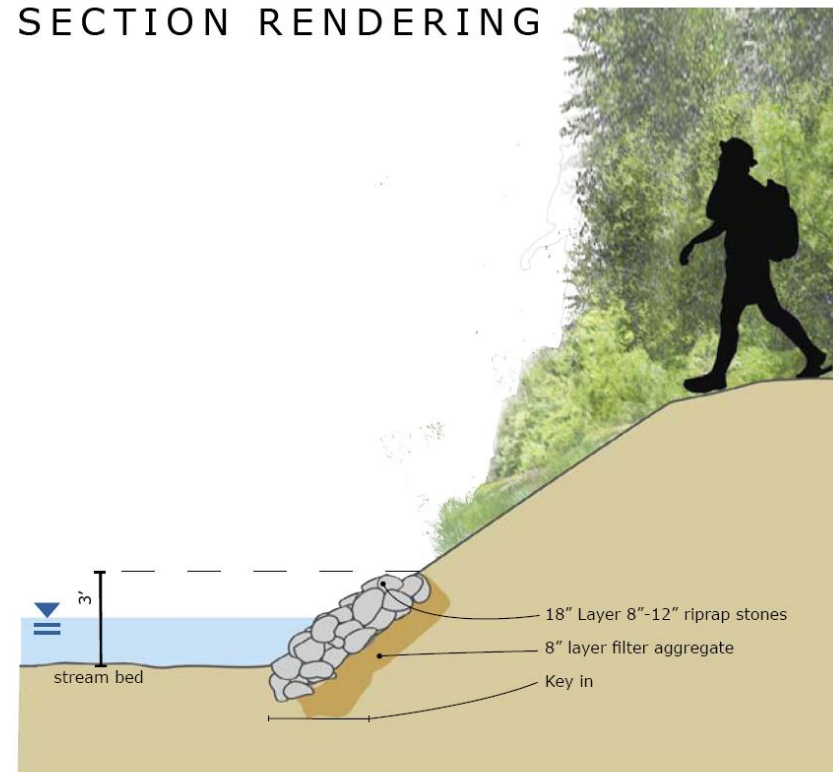

SIMILAR PROJECTS



Stone toe protection has been used extensively in Nine Mile Creek's Lower Valley, in conjunction with deflector dikes, grade control measures and stabilization of large bank failures. Following the 1987 "super storm," the proposed design allowed the stream to continue its course while taking measures to protect areas where water flow was eroding valley walls. The resulting measures have stabilized the stream channel and valley walls while blending seamlessly with the natural environment.

MATERIALS

Materials will consist of cobble-sized material with coarse gravel filter layer to provide separation from the underlying soil. Natural fieldstone material will be used.



Stone Toe Protection

Bank Protection



Stream Stabilization Plan



Rock vanes are constructed from boulders on the creek bottom. They function by diverting channel flow toward the center and away from the bank. They are typically oriented in the upstream direction and occupy no more than one third of the channel width. Vanes are largely submerged and inconspicuous. The rocks are chosen such that they will be large enough to resist movement during flood flows or by vandalism, with additional smaller rock material to add stability. Rock vanes function in much the same way as root wads in that they push the stream thalweg (zone of highest velocity) away from the outside bend. They also promote sedimentation behind the vane, which adds to the toe protection.

Vanes can also be constructed from both banks, forming an upstream-pointing "V." In this configuration, the vane protects both banks and also provides grade control.

MATERIALS

Materials will consist of various gradations of rock, ranging from large, 3-foot boulders to coarse gravel.



SIMILAR PROJECTS



Here is an example of a stabilization project designed for a 1,000-foot long, 20-foot high streambank that was severely eroded. The channel was directed away from the bank toe by installing six rock vanes. The bank was planted with native vegetation and protected with erosion control blanket, while the terrace above the bank was graded to redirect surface runoff to a less vulnerable area. The restored streambank withstood significant flooding during 2001, and has become nicely vegetated (see picture above).

EXISTING CONDITIONS



Fluvial bank erosion is caused by water in the stream moving past the streambanks. The shear stress caused by the flow entrains soil particles into the flow, causing the stream bank to erode away. This is the most common type of erosion that occurs in streams. Virtually all streams experience this type of erosion as their flow path evolves over time. However, the rate of fluvial bank erosion can increase when the stream is out of equilibrium with its watershed. Increased flow from a watershed will increase the rate of fluvial bank erosion. In places where the channel is confined by the valley walls, however, fluvial bank erosion can lead to failure of the high banks. It can also undermine storm sewer inlets.

PLAN/SECTION RENDERING

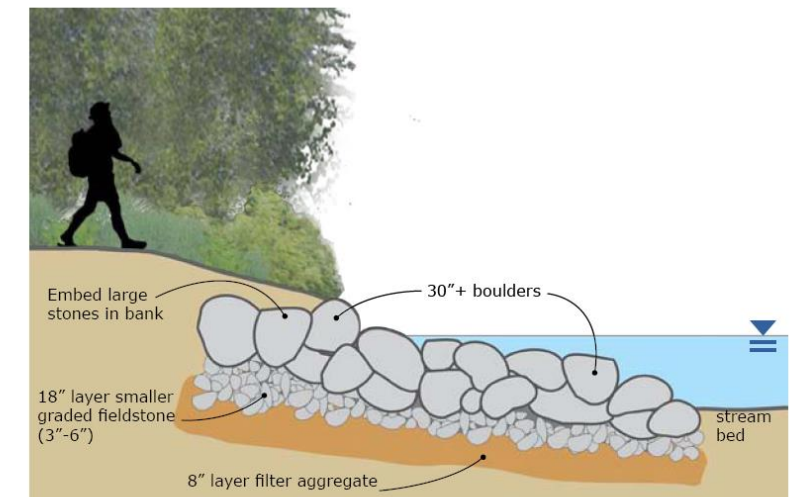
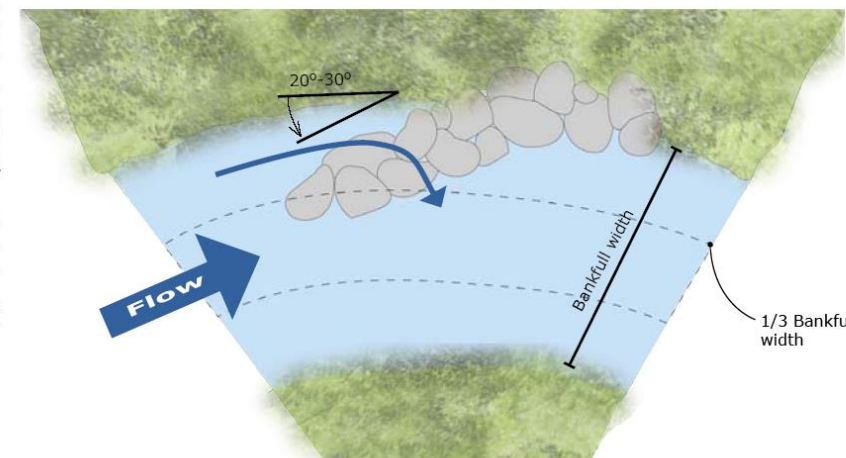

Rock Vanes
Bank Protection **BARR**

Stream Stabilization Plan



EXISTING CONDITIONS



Fluvial bank erosion is caused by water in the stream moving past the streambanks. The shear stress caused by the flow entrains soil particles into the flow, causing the stream bank to erode away. This is the most common type of erosion that occurs in streams.

Virtually all streams experience this type of erosion as their flow path evolves over time. However, the rate of fluvial bank erosion can increase when the stream is out of equilibrium with its watershed. Increased flow from a watershed will increase the rate of fluvial bank erosion.

Soil Pillows are utilized in a bioengineering method known as Vegetated Reinforced Slope Stabilization (VRSS). The method combines rock, geosynthetics, soil and plants to stabilize steep, eroding slopes in a structurally sound manner. VRSS typically involves protecting layers of soils with a blanket or geotextile material (e.g. erosion control blanket) and vegetating the slope by either planting selected species (often willow or dogwood species) between the soil layers or by seeding the soil with desired species before it is covered by the protective material. In either case, with adequate light and moisture, the vegetation grows quickly and provides significant root structure to strengthen the bank. This method tends to be labor intensive and, therefore, relatively expensive.

SECTION RENDERING

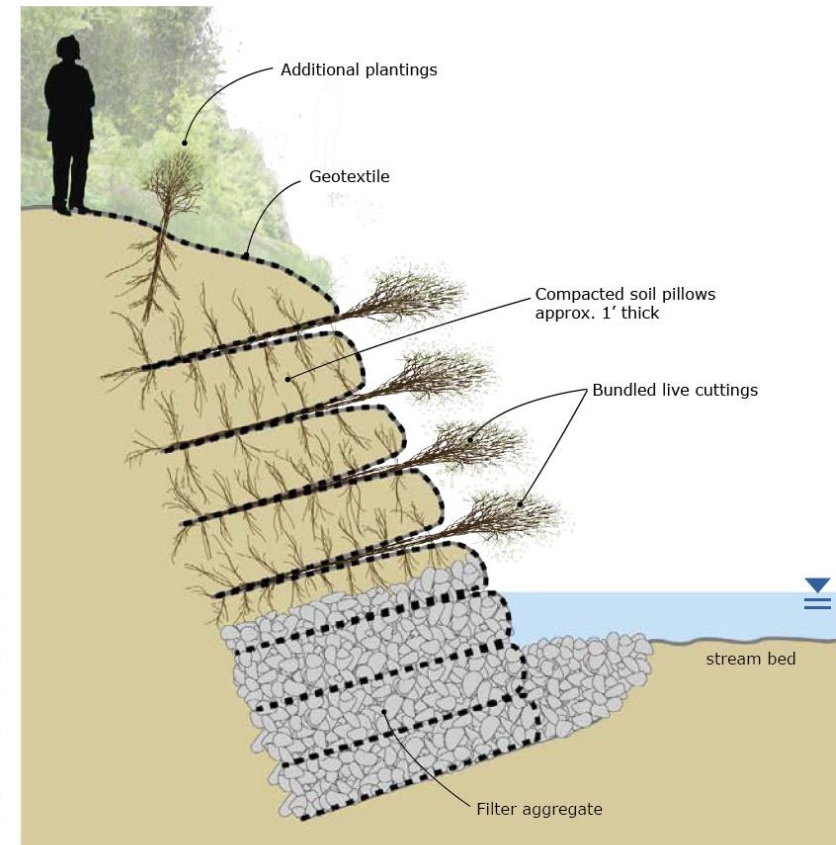

In places where the channel is confined by the steep valley walls, however, fluvial bank erosion can lead to failure of the high banks. It can also undermine storm sewer inlets. For sites where groundwater seepage is a problem and where it is desirable to maintain steep banks, soil pillows are a feasible solution.

SIMILAR PROJECTS



The Mill Creek Restoration Project utilized soil bioengineering design to stabilize 175 linear feet of severely eroding streambanks within the Caldwell Recreation Park in southeastern Ohio. The work included two 25-foot vegetated reinforced soil slope (VRSS) sections, two 50-foot fill bank sections protected with woven coir and direct woody plantings, and a 12.5-foot tie-in on the upstream and downstream end of streambank work area.

MATERIALS

Materials consist of graded rock for the lower layers of the structure and for internal drainage, if necessary. Geotextile fabric is used to wrap the soil. Plants, such as willow or dogwood, or seed mixture is used for planting in and between the soil pillows.



Soil Pillows
Bank Protection **BARR**

Stream Stabilization Plan



EXISTING CONDITIONS



Channel incision occurs when there is an imbalance between the sediment supply and the sediment carrying capacity of the stream. Erosion will occur when the sediment carrying capacity of a stream exceeds the sediment supply. In streams with cohesive banks and steep channel slope, the erosion will first occur primarily on the channel bottom because that is where the erosive forces are the strongest. As the channel deepens, the stream will gradually become wider as the banks eventually fail. The stream will gradually return to equilibrium; however, the process can take many years and significant amounts of erosion will occur during the process.

Grade control measures are used where channel downcutting has occurred. Various types of weirs are commonly used to provide grade control on streams, particularly in steeper systems. Weirs can be constructed of sheetpile, concrete, or natural materials such as rock. In most cases, natural rock is used to emulate natural riffles. Large boulders would comprise the core of the structure, with smaller rock material placed on the upstream and downstream sides of the boulders to provide a gradual transition to the channel.

The riffles will serve to raise the surface of the water profile, and will reconnect the stream to its floodplain areas. Following the installation of the riffles, pools will be created upstream of the riffles. However, these pools will fill with sediment over time, which will in effect raise the channel bottom to the desired elevation.

MATERIALS

Materials will consist of various gradations of rock, ranging from large, 3-foot boulders to coarse gravel.



SECTION/PLAN RENDERING

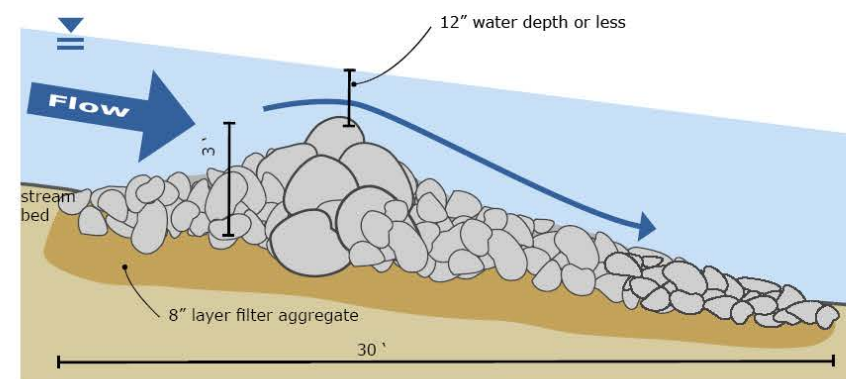

SIMILAR PROJECTS



Following the 1987 "super storm," a rapids was constructed on Nine Mile Creek downstream of the 106th Street Bridge. The rapids was one of several grade-control structures that were installed on a three-mile stretch of creek in the lower valley. The proposal allowed the stream to continue its course while taking measures to protect areas where water flow was eroding valley walls. Protection measures included applying porous deflector dikes, burying sheetpile walls parallel to the creek to prevent undercutting of slopes, installing weirs (rock or capped sheetpile) to limit stream-bed degradation, and improving storm-sewer outlets.

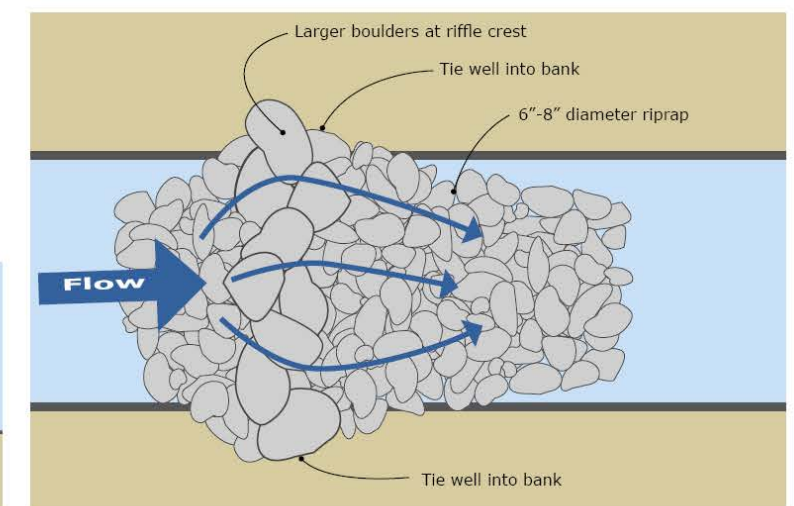

Constructed Riffle
Grade Control **BARR**

Stream Stabilization Plan



EXISTING CONDITIONS



Erosion is frequently observed at culvert outlets for a variety of reasons, including insufficient erosion protection at the culvert outlet, streambank erosion, and channel downcutting, which leaves the culvert perched above the channel. Filter fabric is often used at culvert outlets to separate riprap protection from underlying soils, however the fabric provides a slippery surface for the riprap, which commonly slides into the channel.

Culvert Stabilization is somewhat unique to each situation, depending on the site circumstances. Most sites require additional rock placement with a granular filter layer (rather than filter fabric). Some cases may require re-alignment and/or lowering of the outlet to better align with the stream channel. Typically, outlets should be aligned in the downstream channel direction so that flow doesn't impinge on the opposite bank. It is usually desirable for the culvert to enter the stream at or just above the normal water level in order to minimize the potential for undercutting.

SECTION RENDERING

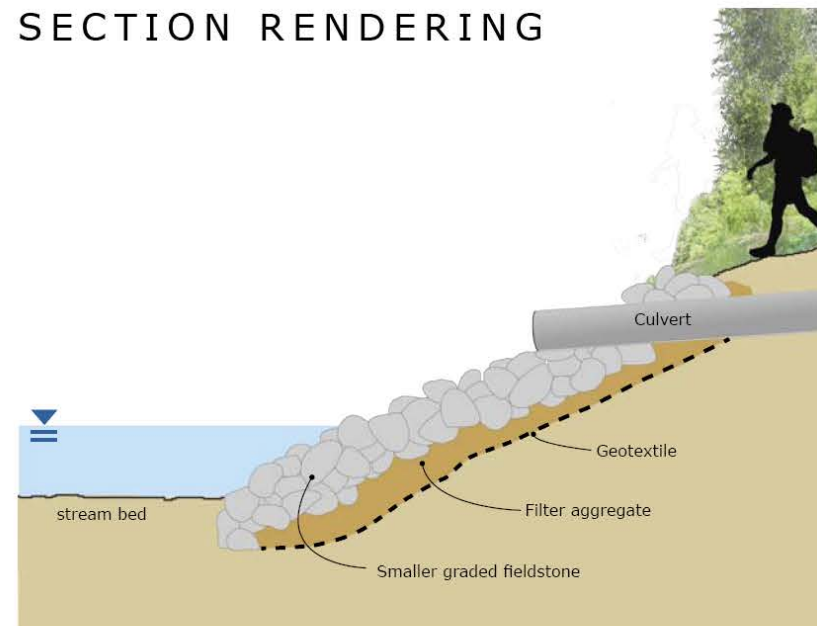

SIMILAR PROJECTS



There are many culvert stabilization designs used on various streams and rivers. Because they are often small projects, the work is often performed by local municipalities or completed as part of a larger project.

MATERIALS

Materials consist of rock materials ranging from graded riprap (either fieldstone, or, for steep slopes, angular) and granular filter material (typically coarse gravel). If necessary, additional pipe, manholes and end sections may be necessary.



Culvert Stabilization

Bank Protection



CADD USER: Adam K. Howard FILE: P:\MPLS\23 MN\27\327051\WORKFILES\CIP\CAPITAL PROJECTS\2017 PLYMOUTH CREEK ANAPOLIS THRU PLYMOUTH CR PK 2017CR-P\FEASIBILITY STUDY\REPORT APPENDICES\APPENDIX E\TOEWOOD.DWG PLOT SCALE: 1:2 PLOT DATE: 12/17/2015 12:31 PM
 Images: E:\Drawings - \DWG\K\...
 User: M:\Design\23270140.DWG 23270140.dwg Plot: 1 07/06/2015 16:12:46

1. INSTALLATION SUMMARY

TOEWOOD BENCH CONSTRUCTION WILL BE DONE IN DRY WEATHER CONDITIONS AFTER STREAM HAS BEEN DIVERTED AND SITE DEWATERED.

ENGINEER OR OWNER'S REPRESENTATIVE MUST BE PRESENT FOR INSTALLATION OF TOEWOOD BENCH.

THE DRAWINGS ON THIS PAGE ARE NOT TO SCALE.

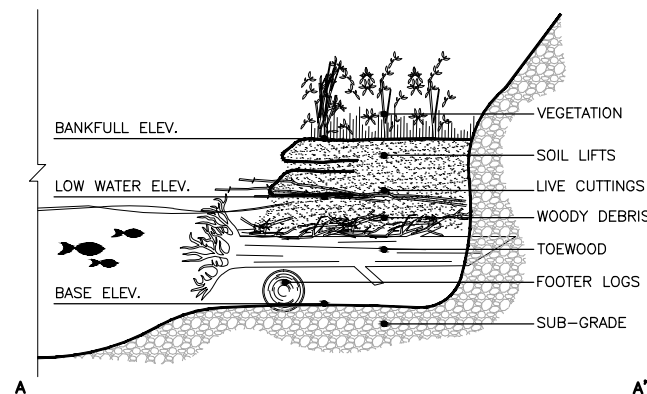

2. SUBGRADE AND FOOTER LOGS

SPECIFICATION:
 -8" TO 1' DIAMETER
 -LIMBS REMOVED
 -APPROX 10' LENGTH

PLACEMENT:
 -EXCAVATE TO BASE ELEVATION - CONTRACTOR SHALL MAKE EFFORT TO SEPARATE GRANULAR AND FINE FILL NATIVE MATERIAL FOR USE IN STEPS 4 AND 6.
 -PLACE FOOTER LOGS 30 DEGREES FROM PARALLEL TO STREAM FLOW WITH ENDS STACKED CREATING A ZIG ZAG PATTERN (PLAN VIEW BELOW)
 -MAINTAIN AVERAGE ELEV. OF 1' ABOVE BASE ELEV.

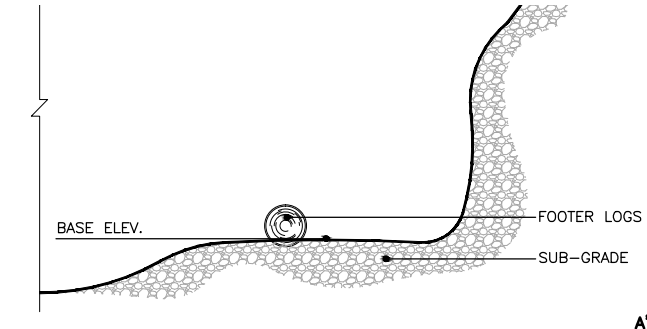

3. ROOT WADS & LRG WOODY DEBRIS

ROOT WAD SPECIFICATION:
 -10" MIN DIAMETER
 -LENGTH INDICATED IN DESIGN CROSS SECTION OR 10' MIN.
 -LIMBS REMOVED
 -ROOT WADS LEFT INTACT
 -ENDS SHARPENED TO A POINT

LARGE WOODY DEBRIS SPECIFICATION:
 -8" MIN DIAMETER

PLACEMENT:
 -PLACE ROOT WADS HORIZONTALLY ON TOP OF FOOTER LOGS, OVERHANG ROOT WAD LOGS 2'
 -ANGLE ROOTWADS UPSTREAM
 -DRIVE SHARPENED TRUNKS MIN. 3' INTO BANK OR DIG IN
 -PLACE 1 ROOT WAD PER FOOTER LOG
 -PLACE 5 TO 7 LARGE WOODY DEBRIS LOGS BETWEEN ROOT WADS

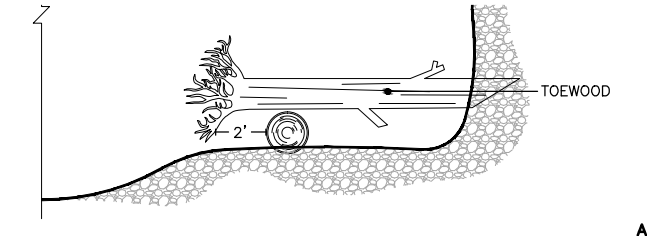

4. WOODY DEBRIS & GRANULAR FILL

SPECIFICATION:
 -WOODY MATERIAL (COMPOSED OF SMALL LIMBS AND BRANCHES, APPROX. 4" MAX DIAMETER AND SMALLER)
 -DO NOT USE ROTTEN WOODY MATERIAL
 -NATIVE GRANULAR FILL

PLACEMENT:
 -FILL BETWEEN FOOTER LOGS AND TOEWOOD WITH WOODY DEBRIS
 -STACK WOODY DEBRIS TO LOW WATER ELEVATION
 -LAYER NATIVE GRANULAR FILL ON TOP OF WOODY DEBRIS
 -COMPACT SO THAT SETTLING OF FILL IS MINIMIZED BUT DEBRIS IS NOT DISPLACED
 -COMPACTED FILL WILL MEET 2"-5" ABOVE LOW WATER ELEVATION

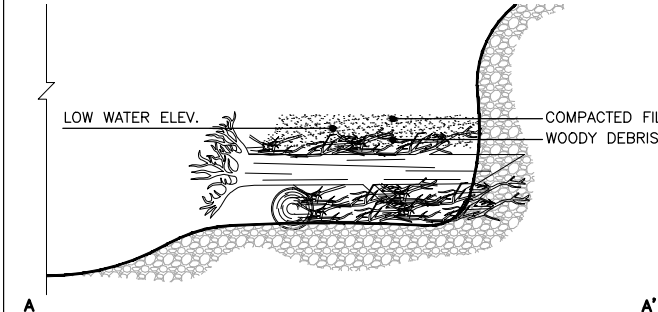

5. LIVE CUTTINGS

SPECIFICATION:
 -SEE LIVE CUTTING DETAIL

PLACEMENT:
 -LAY CUTTINGS WITH A DENSITY OF 10 CUTTINGS PER LINEAL FOOT
 -TOPS OF CUTTING WILL POINT TOWARD CHANNEL
 -TRIM EXPOSED ENDS OF CUTTINGS, LEAVE NO MORE THAN 6" EXPOSED
 -DEPOSIT NATIVE FILL OVER CUTTINGS AND WATER LIBERALLY, COMPRESS FILL TO 2"- 4"

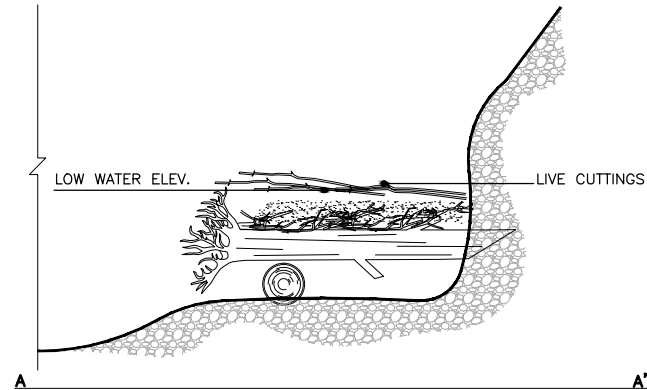

6. SOIL LIFTS

SPECIFICATION:
 -NATIVE FILL (FINE)
 -1' FORMS
 -MIN 6.5' WIDE ROLANKA BIOD-MAT 70, GEOCOIR 700, OR EQUAL LINED WITH MNDOT CAT II EROSION CONTROL BLANKET WITH NATURAL NETTING
 -18" WOODEN STAKES (2X4 CUT AT ANGLE), PLACED AT 3' SPACING

PLACEMENT:
 -PLACE FORM
 -LAY MIN 2.5' OF FABRIC (COCONUT BLANKET AND LINER) ALONG BENCH
 -PLACE 1' OF FILL ON TOP OF MAT AND COMPACT
 -WRAP FILL WITH REMAINING BLANKET AND SECURE WITH STAKES
 -REPEAT UNTIL BANKFUL ELEVATION IS MET, STEP EACH LIFT BACK 1'
 -FOR TOP SOIL LIFT, EXTEND BLANKET TO EXISTING GRADE/BANK

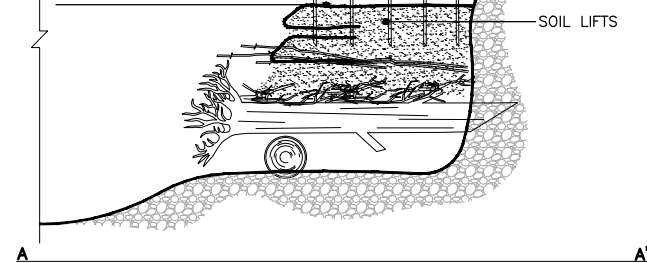

7. VEGETATION

SEE VEGETATION PLAN FOR DETAIL

IF SEED IS CALLED FOR:
 -PLANT SEED INSIDE OF SOIL LIFT PRIOR TO COVERING IN FABRIC
 -PLANT SEED ON THE FACE OF EACH SOIL LIFT AS WELL AS ACROSS THE TOP SOIL LIFT

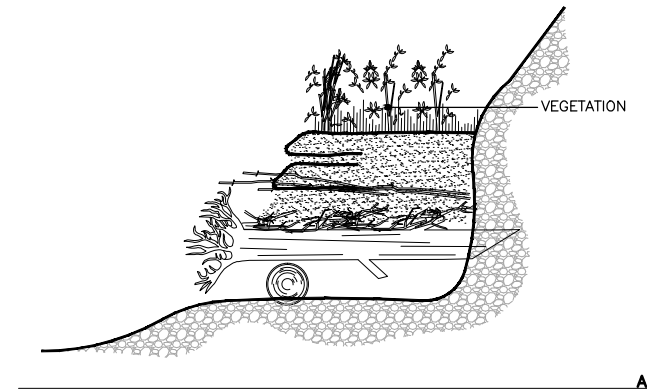

8. SILL LOGS & TERMINATION

SPECIFICATION:
 -10" MIN DIAMETER
 -LIMBS REMOVED
 -LENGTH DETERMINED BY WIDTH OF TOEWOOD BENCH

PLACEMENT:
 -PLACE ONE SILL LOG AT THE START AND END OF THE TOEWOOD BENCH PERPENDICULAR TO THE DIRECTION OF FLOW.
 -PLACE LARGE ROCKS ON TOP OF SILL LOG, TOP OF ROCK WILL MEET BANKFULL ELEVATION
 -TUCK SOIL LIFT BLANKET DOWN AND BACK TOWARDS EXISTING BANK
 -TRANSITION BANKFUL ELEVATION TO EXISTING GRADE AT DETERMINED LOCATION AT START AND END OF BENCH

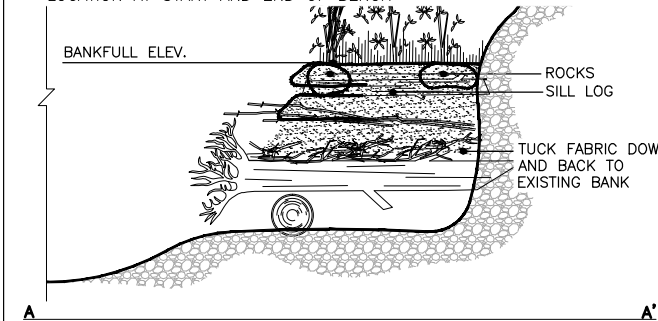

NO.	BY	CHK.	APP.	DATE	REVISION DESCRIPTION

I HEREBY CERTIFY THAT THIS PLAN, SPECIFICATION, OR REPORT WAS PREPARED BY ME OR UNDER MY DIRECT SUPERVISION AND THAT I AM A DULY LICENSED PROFESSIONAL ENGINEER UNDER THE LAWS OF THE STATE OF MINNESOTA.

SIGNATURE _____
 PRINTED NAME _____
 DATE _____ REG. NO. _____

CLIENT											
BID											
CONSTRUCTION											
RELEASED TO/FOR	A	B	C	0	1	2	3				
DATE RELEASED											

BARR
 Corporate Headquarters:
 Minneapolis, Minnesota
 Ph: 1-800-632-2277

Project Office:
BARR ENGINEERING CO.
 4700 WEST 77TH STREET
 MINNEAPOLIS, MN.
 55435-4803
 Ph: 1-800-632-2277
 Fax: (952) 832-2601
 www.barr.com

Scale	AS SHOWN
Date	2/10/2015
Drawn	GGN
Checked	JDW
Designed	GGN
Approved	JDW

TOE WOOD
 EXAMPLE DETAIL

BARR PROJECT No.	
CLIENT PROJECT No.	
DWG. No.	REV. No.
C1.0	0

CADD USER: ADAM K. HOWARD, FILE: P:\MPLS\23 MN\27\2327053\WORKFILES\TASK ORDERS\10_14_LOWER_RILEY_FEASIBILITY_STUDY\FEASIBILITY_STUDY\REPORT\APPENDICES\APPENDIX 1 - STABILIZATION EXAMPLES\CEDARPILINGS.DWG, PLOT SCALE: 1:2, PLOT DATE: 10/9/2016 3:25 PM

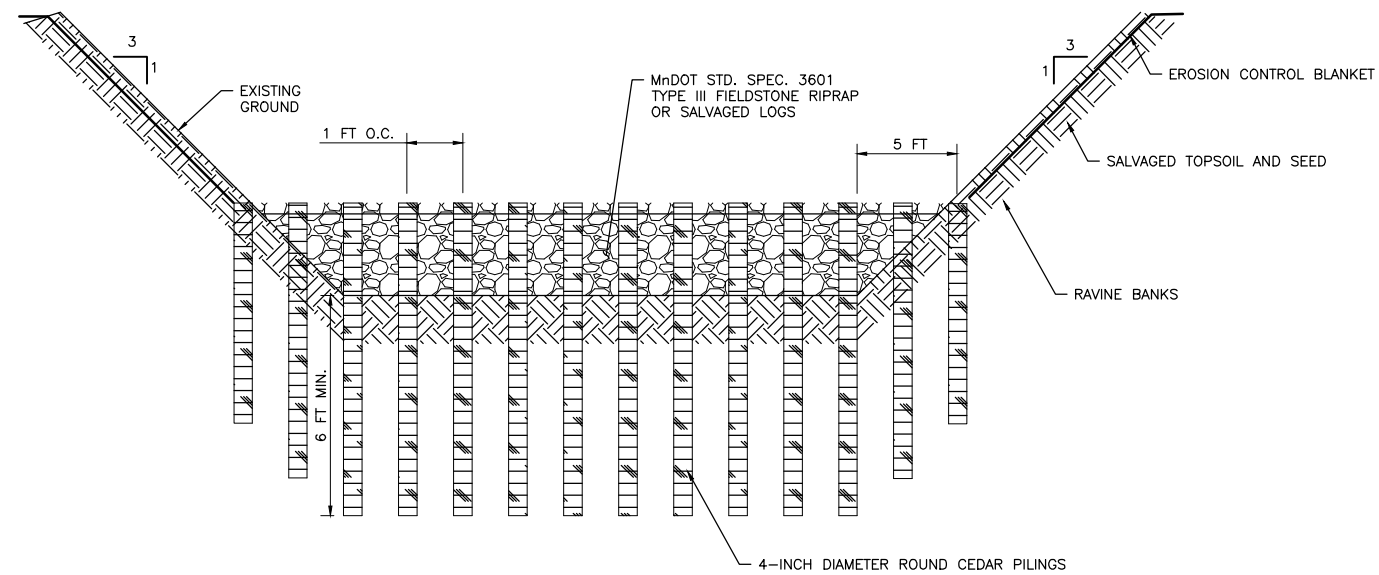

1 DETAIL: CEDAR PILINGS
NOT TO SCALE

CEDAR PILINGS SPECIFICATIONS:

1. CEDAR PILING MATERIAL: 4-INCH DIAMETER ROUND NORTHERN WHITE CEDAR; CUT FROM LIVE, GROWING TREES; MANUFACTURED IN ACCORDANCE WITH Mn/DOT STD. SPEC. 3413C
2. DRIVE POSTS AT THE SPACING AND TO THE PENETRATION DEPTHS SHOWN ON THE DRAWINGS
3. TOP OF POSTS APPROXIMATELY 0.5-FT. ABOVE CHANNEL BOTTOM.
4. IN THE EVENT THAT POSTS CANNOT BE DRIVEN, EXCAVATE A NARROW TRENCH, BACKFILL WITH GRANULAR FILL AT LEAST 4 FEET IN DEPTH, AND THEN DRIVE POSTS TO THE ELEVATIONS SHOWN ON THE DRAWINGS. BACKFILL TO EXISTING GRADE WITH GRANULAR FILL.
5. EXCAVATE 2 FEET BEHIND PILINGS AND BACKFILL WITH 8" MnDOT STD. SPEC 3601 GRANULAR FILTER MATERIAL AND TYPE III FIELDSTONE RIPRAP AS SHOWN ON DRAWING.
6. BACKFILL WITH EXISTING MATERIAL TO EXISTING GRADE.
7. ON ALL DISTURBED BANKS AND AREAS REPLACE SALVAGED TOPSOIL, RE-VEGETATE AND STABILIZE WITH EROSION CONTROL BLANKET AS SPECIFIED IN THE CONTRACT DOCUMENTS.

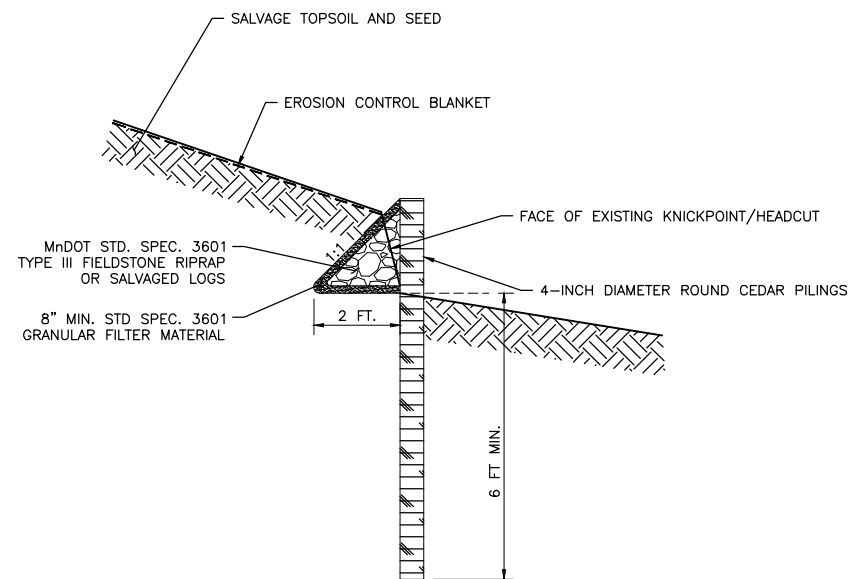

2 SECTION: CEDAR PILINGS
NOT TO SCALE

NO.	BY	CHK.	APP.	DATE	REVISION DESCRIPTION

I HEREBY CERTIFY THAT THIS PLAN, SPECIFICATION, OR REPORT WAS PREPARED BY ME OR UNDER MY DIRECT SUPERVISION AND THAT I AM A DULY LICENSED PROFESSIONAL ENGINEER UNDER THE LAWS OF THE STATE OF MINNESOTA.

PRINTED NAME: _____
SIGNATURE: _____
DATE: _____ LICENSE # _____

CLIENT									
BID									
CONSTRUCTION									
PERMITTING									
RELEASED TO/FOR	A	B	C	0	1	2	3		
DATE RELEASED									

BARR ENGINEERING CO.
4300 MARKETPOINTE DRIVE
Suite 200
MINNEAPOLIS, MN 55435

Project Office:
BARR ENGINEERING CO.
4300 MARKETPOINTE DRIVE
Suite 200
MINNEAPOLIS, MN 55435
Ph: 1-800-632-2277
Fax: (952) 832-2601
www.barr.com

Corporate Headquarters:
Minneapolis, Minnesota
Ph: 1-800-632-2277

Scale	AS SHOWN
Date	6/15/16
Drawn	JPP
Checked	LAD
Designed	JPP
Approved	LAD

CEDAR PILES AND RIPRAP APRON DETAILS		BARR PROJECT No.
		CLIENT PROJECT No.
DWG. No.	REV. No.	0

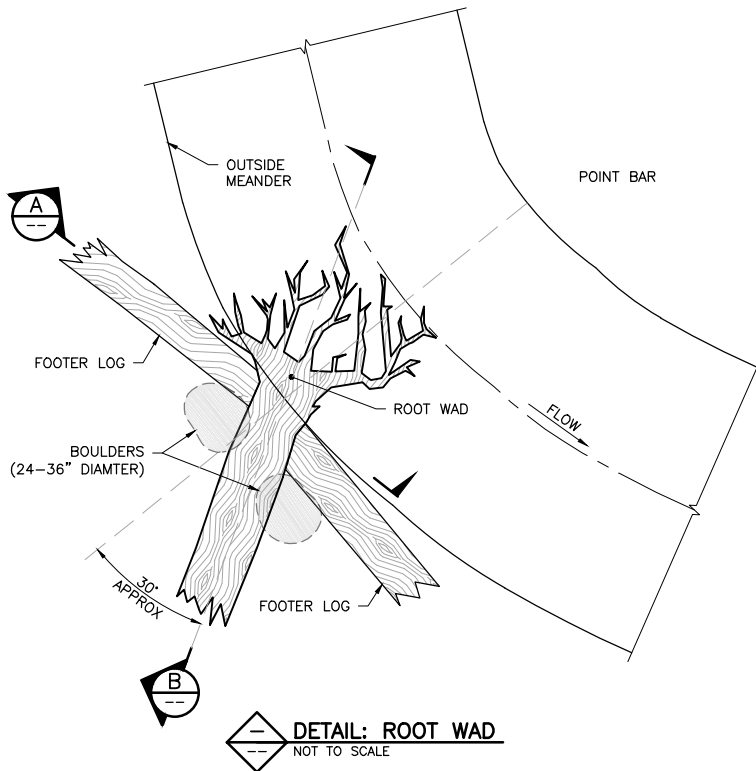

GENERAL NOTES:

1. THE ENGINEER MUST BE NOTIFIED AT LEAST 3 DAYS PRIOR TO ROOT WAD INSTALLATION AND MUST BE ON SITE DURING INSTALLATION.
2. TO THE EXTENT POSSIBLE, ROOT WADS SHOULD BE CREATED FROM TREES THAT WILL BE REMOVED FROM THE SITES WITHIN THE PROJECT AREA.
3. CONSTRUCTION SHOULD PROCEED FROM DOWNSTREAM TO UPSTREAM IN AREAS WHERE MORE THAN ONE ROOT WAD WILL BE INSTALLED AS SHOWN ON THE DRAWINGS.
4. EXCAVATE A TRENCH ALONG THE STREAMBANK TOE FOR THE FOOTER LOGS.
5. PLACE THE FOOTER LOGS INTO THE TRENCH, WITH THE TOPS OF THE LOGS AT SPECIFIED ELEVATIONS FOR EACH SITE.
6. EXCAVATE A TRENCH IN WHICH TO PLACE THE ROOT WAD. IN SOFT SOILS IT MAY BE POSSIBLE TO DRIVE THE ROOT WAD INTO THE BANK WITH EQUIPMENT AFTER SHARPENING THE END TO A POINT. CARE SHALL BE TAKEN NOT TO DAMAGE THE ROOT WAD.
7. THE ROOT WAD MUST BE PLACED IN THE BANK SO THAT THE BACK OF THE ROOT FAN RESTS AGAINST THE FRONT OF THE FOOTER LOG.
8. THE ROOT FAN MUST BE PLACED SUCH THAT THE FAN IS ANGLED UPSTREAM AS SHOWN AND AS DIRECTED BY THE ENGINEER.
9. MOVING UPSTREAM, THE PROCESS IS REPEATED FOR EACH ADDITIONAL ROOT WAD AS SHOWN ON THE DRAWINGS.
10. LARGE BOULDERS ARE PLACED ON EITHER SIDE OF THE TRUNK OF EACH ROOTWAD.
11. PLACE BACK FILL OVER THE BOULDERS AS NECESSARY WITH A COARSE FILTER AGGREGATE (MN/DOT STANDARD SPECIFICATION 3142.2H) AND MATCH EXISTING GRADE WITH 6" OF TOPSOIL.
12. REVEGETATE AND STABILIZE WITH EROSION CONTROL BLANKET AS SPECIFIED FOR EACH SITE AS SHOWN IN THE DRAWINGS AND DIRECTED BY THE ENGINEER.
13. TRIM THE ROOTS THAT EXTEND ABOVE THE STREAM BANK TO A HEIGHT SLIGHTLY BELOW BANK HEIGHT AS DIRECTED BY THE ENGINEER.

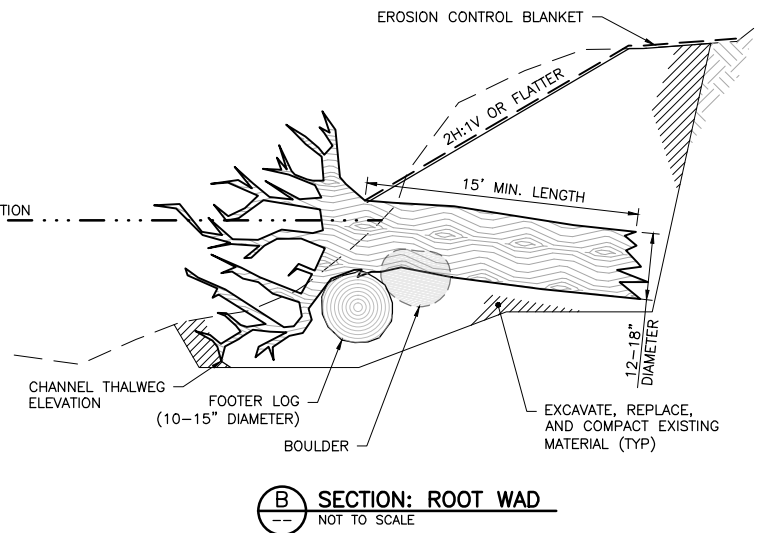
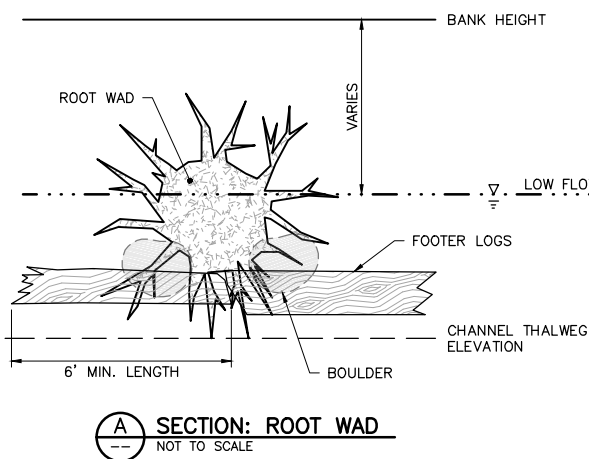

STREAM RESTORATION DETAILS
BANK PROTECTION
ROOT WAD



CREATED BY: PEB
LAST EDITED BY: PEB, 10/9/16
KNOWLEDGEABLE PERSONS:
JTL2, TEM, PJH2, JDW