

## Riley Purgatory Bluff Creek Watershed District Permit Application Review

**Permit No:** 2023-005

**Considered at Board of Managers Meeting:** April 12, 2023

**Received complete:** March 10, 2023

**Applicant:** City of Eden Prairie

**Consultant:** City of Eden Prairie, Patrick Sejkora, PE

**Project:** Sunnybrook Road Culvert and Storm Sewer Improvements – The proposed project includes replacement of an existing 24-inch culvert under Sunnybrook Road in the vicinity of Homeward Hills Road in Eden Prairie. The culvert is in the Purgatory Creek watershed and connects two wetlands: 23-34-A, a public water wetland, on the upstream end and 23-34-B on the downstream end.

**Location:** Sunnybrook Road & Homeward Hills Road, Eden Prairie, MN

**Reviewer:** Scott Sobiech, PE, Barr Engineering

### Proposed Board Action

Manager \_\_\_\_\_ moved and Manager \_\_\_\_\_ seconded adoption of the following resolutions based on the permit report that follows and the presentation of the matter at the April 12, 2023 meeting of the managers. Resolved that the application for Permit 2023-005 is approved, subject to the conditions and stipulations set forth in the Recommendations section of the attached report;

Resolved that on determination by the RPBCWD administrator that the conditions of approval have been affirmatively resolved, the RPBCWD president or administrator is authorized and directed to sign and deliver Permit 2023-005 to the applicant on behalf of RPBCWD.

Upon vote, the resolutions were adopted, \_\_\_\_\_ [VOTE TALLY].

### Rule Conformance Summary

Rule	Issue	Conforms to RBPCWD Rules?	Comments
B	Floodplain Management and Drainage Alterations	Yes	
C	Erosion Control Plan	See Comment	See Rule Specific Permit Condition C1.
D	Wetland and Creek Buffer	See Comment	See Rule Specific Permit Condition D1.
G	Waterbody Crossing and Structures	See Comment	See Rule Specific Permit Condition G1-G2.
L	Permit Fee	NA	Governmental Entity
M	Financial Assurance	NA	Governmental Entity

## **Project Background**

The existing culvert beneath Sunnybrook Road is a 24-inch circular reinforced concrete pipe. The pipe connects two wetlands 23-34-A (a public water) and 23-34-B within the Purgatory Creek watershed. The existing culvert has areas with as little as 1.2 feet of cover, which does not meet MnDOT minimum cover requirements of 1.75 feet for flexible pavement.

The City is proposing to replace the culvert under the roadway with a 19-inch x 30-inch elliptical reinforced concrete pipe to achieve MnDOT's minimum cover requirements. Soil corrections will also be made around and under the proposed culvert to prevent heaving. In addition, the City will be replacing sections of corroded CMP and dislocated RCP storm sewer in the vicinity of the culvert replacement. This system was constructed in the 1960s and the deficiencies were observed by City inspection. The work will also include the reconstruction of pedestrian ramps at the intersection of Sunnybrook Road and Homeward Hills Road and to the north along Homeward Hills Road. All work is within right-of-way owned by the City of Eden Prairie.

Because the project is a linear project and does not exceed the disturbance thresholds for in Rule J, subsection 2.4, RPBCWD stormwater management rule does not impose requirements on this project. The project site information is summarized below:

<b>Description</b>	<b>Area (acres)</b>
Total Site Area	0.144
Existing Site Impervious	0.137
Post-Construction Site Impervious	0.137
Change in Site Impervious Area	0.0
Disturbed Impervious Surface	0.137 (100% disturbed)
Total Disturbed Area	0.144

### Exhibits:

1. Permit Application received February 14, 2023 (applicant was notified of an incomplete application on March 1, 2023; information completing the application was received on March 10, 2023)
2. Project Narrative Memorandum dated February 14, 2023 (revision dated March 10, 2023)
3. Design Plans Sheets dated February 14, 2023 (revision dated March 7, 2023)
4. Existing and Proposed Conditions PCSWMM Models for 2-, 10-, and 100-year events received February 14, 2023
5. WCA Application and Notice of Decision received February 17, 2023
6. Response to RPBCWD Comments on March 1, 2023 dated March 10, 2023

7. MNRAM for 23-34-B received March 10, 2023
8. March 8, 2023 email from MnDNR Area Hydrologist waive jurisdiction to WCA for any wetland impacts

### **Rule Specific Permit Conditions**

#### **Rule B: Floodplain Management and Drainage Alterations**

Because the project disturbs land below the 100-year flood elevation of two wetlands to repair the culvert under Sunnybrook Road, the project must conform to the requirements in the RPBCWD Floodplain Management and Drainage Alteration rule (Rule B, Subsection 2.1).

The proposed culvert rehabilitation project conforms to Rule B, Subsections 3.1 because no buildings are proposed to be constructed or reconstructed as part of the project. Placement of fill below the 100-year flood elevation is prohibited unless fully compensatory storage at or below the same elevation for fill in the floodplain of a water basin and within the floodplain of the same waterbody is provided (Rule B, Subsection 3.2). The supporting materials demonstrate, and the RPBCWD Engineer concurs, that the project conforms to these criteria by matching existing grades. The existing riprap at the downstream end of the existing culvert will be removed and replaced in-kind resulting in no floodplain fill.

The RPBCWD engineer concurs with the hydraulic analysis conducted by the applicant's engineer which demonstrates that the project will not materially alter surface flows. The analysis also demonstrates that the flow velocities for the 2-, 10-, and 100-year events will be slightly lower than existing conditions confirming that the proposed project is not reasonably likely to have adverse downstream impacts (Rule B, Subsection 3.3).

The proposed project conforms to the floodplain management and drainage alteration requirements of Rule B.

#### **Rule C: Erosion and Sediment Control**

Because the project will involve 0.144 acres of land-disturbing activities, the project must conform to the requirements in the RPBCWD Erosion and Sediment Control rule (Rule C, Subsection 2.1).

The erosion control/turf restoration plan includes installation of biolog, inlet protection for storm sewer catch basins, floating silt curtain, turf establishment, daily inspection, placement of a minimum of 6 inches of topsoil, decompaction of areas compacted during construction, and retention of native topsoil onsite. To conform to the RPBCWD Rule C requirements the following revisions are needed:

- C1. The Applicant must provide the name and contact information of the individual responsible for erosion control at the site. RPBCWD must be notified if the responsible individual changes during the permit term.

**Rule D: Wetland and Creek Buffers**

Because the proposed work triggers RPBCWD Rule B and G for the crossing replacement work and the onsite wetlands are downgradient from the proposed construction activities, Rule D, Subsections 2.1a requires buffers adjacent to the waterbodies. Because the MnDNR waived jurisdiction to WCA for any wetland impacts to wetland 23-34-A (a public water wetland), the wetland is disturbed solely for utility repairs, and a No Loss decision for the wetland has been determined by the local governmental unit, City of Eden Prairie, and the requirements of Rule D do not apply to wetland 23-34-A (Rule D, subsection 2.2b).

The section of culvert that discharges to 23-34-B is being replaced with a 30-inch wide elliptical RCP resulting in permanent wetland impacts to 23-34-B due to the increased footprint of the pipe. Because Wetland 23-34-B (a medium value wetland) is disturbed by the proposed work, a wetland buffer is required around the entire wetland (Rule D, subsection 3.1.a) on property owned by the city (Rule D, subsection 3.2f). An average buffer width of 40 feet and a minimum buffer width of 20 feet is required in accordance with Rule D, Subsection 3.2.a.iii but limited in width to the extent of available right-of-way (ROW) (Rule D, Subsection 3.2g). The buffer widths are summarized in the following table

Wetland ID	RPBCWD Wetland Value	Required Minimum Width <sup>1</sup> (ft)	Required Average Width <sup>1</sup> (ft)	Provided Minimum Width (ft)	Provided Average Width (ft)
Wetland 23-34-B	Medium	20	40	16	18

<sup>1</sup> Average and minimum required buffer width under Rule D, Subsection 3.1.a.

The Applicant provided buffer zone and marker location information on the construction drawings confirming that the proposed buffer area extends to the right-of-way limits in conformance with Rule D, subsection 3.2g. The storm sewer and erosion control plan require revegetating disturbed areas within the proposed buffer with native vegetation and show wetland buffer marker locations which conforms with Rule D, Subsection 3.3. A note is included on the plan sheet indicating the project will be constructed so as to minimize the potential transfer of aquatic invasive species (e.g., zebra mussels, Eurasian watermilfoil, etc.) to the maximum extent possible conforming to Rule D, Subsection 3.5.

To conform to the RPBCWD Rule D the following revisions are needed:

D1. Buffer areas and maintenance requirements must be documented in an agreement after review and approval by RPBCWD in accordance with Rule D, Subsection 3.5. RPBCWD and Eden Prairie have entered into a programmatic maintenance agreement covering city projects subject to RPBCWD regulatory requirements. The buffers associated with this permit (2023-005) must be incorporated into the inventory of those managed in accordance with the programmatic agreement as a condition of approval.

**Rule G: Waterbody Crossings and Structures**

Because the project will replace an existing waterbody crossing in contact with the bank of each of wetlands 23-34-A (a public water) and 23-34-B, the project must conform to all applicable criteria in RPBCWD’s Rule G - Waterbody Crossing and Structures.

This work represents a public benefit by replacing an existing culvert that is susceptible to heaving leading to disruption along the public roadway (shown in photos below). In addition, the project involves the repair of deteriorating public infrastructure (Rule G, Subsection 3.1a and 3.1b).



**Photos of heaving pavement over culvert crossing**

The proposed crossing was modeled in PCSWMM by the applicant. The analysis shows that the proposed 100-year frequency flood elevation upstream of the crossing (815.4 feet) will match the existing elevation 815.4 feet and the downstream flood elevation will also match the existing flood elevation of 814.2 feet, thus confirming the project will not increase the flood stage of the existing wetlands conforming to Rule G, Subsection 3.2a.

The existing crossing is not used for navigation, so Rule G, Subsection 3.2b does not impose any requirements on the project. The applicant provided modeling demonstrating the project will not adversely affect water quality or cause increased scour, erosion, or sedimentation because the project maintains (or slightly reduces) flow velocities through the culvert to the downstream wetland. Because the proposed riprap can withstand velocities between 6 – 8 fps, and the modeled 100-year velocity at the downstream end of the culvert is 5.8 fps, stabilization materials are sized and designed appropriately to withstand the velocities and shear stresses through the culvert consistent with the criteria in Rule G, Subsection 3.2c. Because the proposed culvert has a flow area that is similar to

existing, wildlife will continue to be able to use the crossing as it is used under existing conditions, thus preserving wildlife passage, thus consistent with Rule G, Subsection 3.2d.

A no-build option would result further deterioration of the pavement section over the existing culvert. The required repair after continuous heaving would represent a risk for construction related sediment entering the downstream wetland. Increasing cover over the pipe was considered but not pursued given that the grades required to raise the road profile would result in additional wetland impacts and/or floodplain fill. The proposed option has the smallest impact to the surrounding wetlands which is consistent with Rule G, Subsection 3.2e.

Energy dissipation in the form of a stilling basin to reduce erosion potential will be provided at the downstream end of the proposed culvert (Rule G, Subsection 3.3).

Banks will be immediately stabilized after completion of permitted work and revegetated as soon as growing conditions allow (Rule G, Subsection 3.7b). A note is included on the plan sheet indicating the project will be constructed so as to minimize the potential transfer of aquatic invasive species (e.g., zebra mussels, Eurasian watermilfoil, etc.) to the maximum extent possible (Rule G, Subsection 3.7c).

Rule G, Subsection 3.7d requires compliance with the applicable criteria in subsections 3.3 of Rule F. Construction drawings submitted confirm that riprap is sized appropriately in relation to the erosion potential: The project proposes the use a durable natural stone riprap having an average size of 6 inches in diameter (MNDOT Class II Riprap). Because the proposed riprap can withstand velocities between 6 – 8 fps, and the modeled 100-year velocity at the downstream end of the culvert is 5.8 fps, the project conforms to Rule F, Subsection 3.3b (i). Drawings confirm the proposed crossing will follow the existing alignment (Rule F, Subsection 3.3b (ii) and 3.3b (iv)). The standard riprap detail included with the drawings indicate that a granular transitional layer and a geotextile fabric will be placed, thus conforming to Rule F, Subsection 3.3b (iii). The drawings illustrate that the proposed riprap will extend to the top of bank, which is lower than the 100-year flood elevation, thus conforming to Rule F Subsection 3.3b (v). The riprap design reflects energy dissipation and stabilization necessary to minimize erosion at the watercourse and is not placed for cosmetic purposes per Rule F, Subsection 3.3b (vi).

To conform to the RPBCWD Rule G the following revisions are needed:

- G1. A note must be added to the Erosion Control & General Notes, Seq & Details sheet requiring no activity conducted between March 15 and June 15. (Rule G, subsection 3.7a.)
- G2. RPBCWD and Eden Prairie have entered into a programmatic maintenance agreement covering city projects subject to RPBCWD regulatory requirements. The waterbody crossing associated with this permit (2023-005) must be incorporated into the inventory of those managed in accordance with the programmatic agreement as a condition of approval.

### **Applicable General Requirements:**

1. The RPBCWD Administrator and Engineer shall be notified at least three days prior to commencement of work.
2. Construction must be consistent with the plans, specifications, and models that were submitted by the applicant that were the basis of permit approval. The date(s) of the approved plans, specifications, and modeling are listed above and on the permit. The granting of the permit does not in any way relieve the permittee, its engineer, or other professional consultants of responsibility for the permitted work.
3. The grant of the permit does not relieve the permittee of any responsibility to obtain approval of any other regulatory body with authority.
4. The issuance of this permit does not convey any rights to either real or personal property, or any exclusive privileges, nor does it authorize any injury to private property or any invasion of personal rights, nor any infringement of federal, state, or local laws or regulations.
5. In all cases where the doing by the permittee of anything authorized by this permit involves the taking, using or damaging of any property, rights or interests of any other person or persons, or of any publicly owned lands or improvements or interests, the permittee, before proceeding therewith, must acquire all necessary property rights and interest.
6. RPBCWD's determination to issue this permit was made in reliance on the information provided by the applicant. Any substantive change in the work affecting the nature and extent of applicability of RPBCWD regulatory requirements or substantive changes in the methods or means of compliance with RPBCWD regulatory requirements must be the subject of an application for a permit modification to the RPBCWD.
7. If the conditions herein are met and the permit is issued by RPBCWD, the applicant, by accepting the permit, grants access to the site of the work at all reasonable times during and after construction to authorized representatives of the RPBCWD for inspection of the work.

### **Findings**

1. The proposed project includes the information necessary, plan sheets and erosion control plan for review.
2. The proposed project conforms to Rule B.
3. The proposed project will conform to Rules C, D, and G if the conditions listed above are met.
4. Under Minnesota Department of Natural Resources General Permit 2015-1192 (attached to this report), approval of work under RPBCWD rule(s) G constitutes approval under applicable DNR work in waters rules. Compliance with conditions on approval and payment of applicable fees, if any, are necessary to benefit from general permit approval and the responsibility of the applicants.

### **Recommendation:**

Approval of the permit contingent upon:

1. Continued compliance with General Requirements.
2. The Applicant must provide the name and contact information of the individual responsible for erosion control at the site. RPBCWD must be notified if the responsible individual changes during the permit term.
3. Receipt of an updated Erosion Control & General Notes, Seq & Details sheet with a note requiring no activity conducted between March 15 and June 15.
4. RPBCWD and Eden Prairie have entered into a programmatic maintenance agreement covering city projects subject to RPBCWD regulatory requirements. The buffers and waterbody crossing associated with this permit (2023-005) must be incorporated into the inventory of those managed in accordance with the programmatic agreement as a condition of approval.



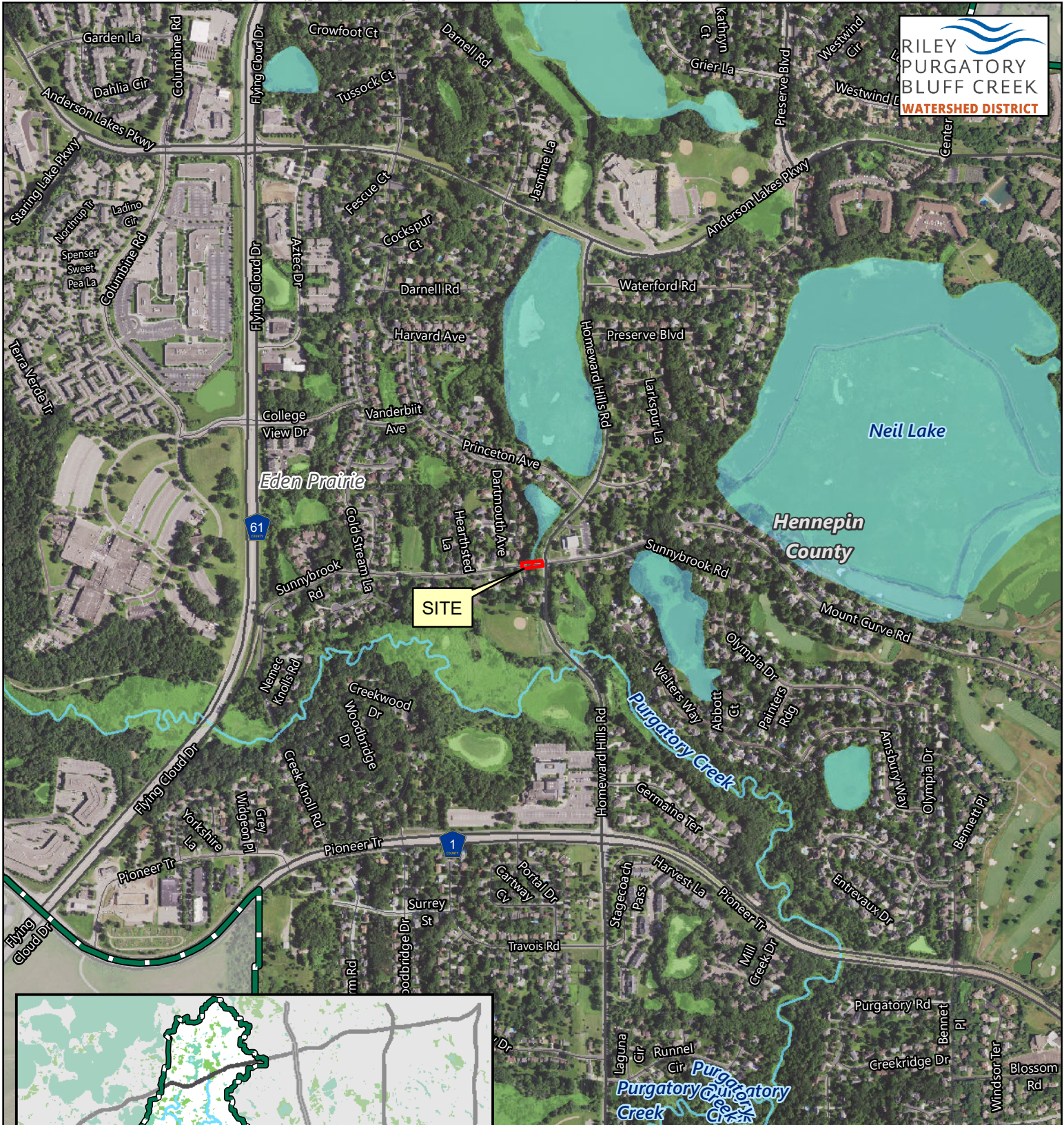

SITE

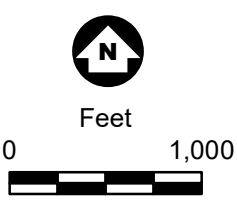
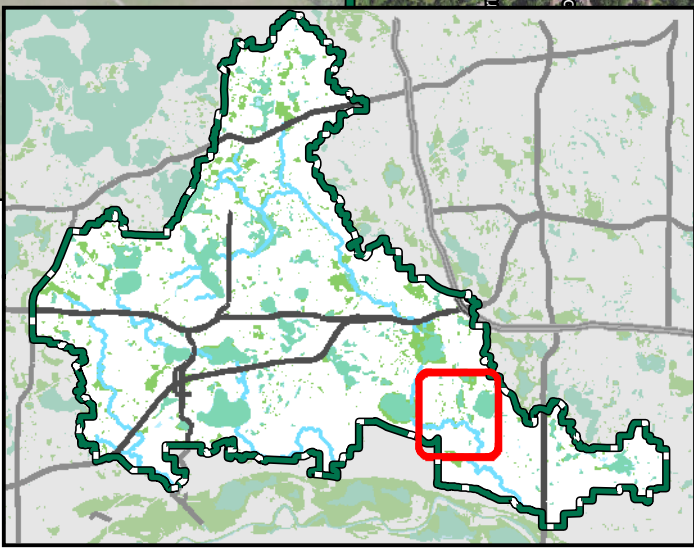

Permit Location Map

SUNNYBROOK RD CULVERT  
REPLACEMENT  
**Permit 2023-005**  
Riley Purgatory Bluff Creek  
Watershed District

# CITY OF EDEN PRAIRIE

HENNEPIN COUNTY, MINNESOTA

**BID PLANS FOR:**  
**SUNNYBROOK CULVERT REPLACEMENT & ADA PEDESTRIAN RAMP PROJECT**  
 CITY PROJECT NO. 23809

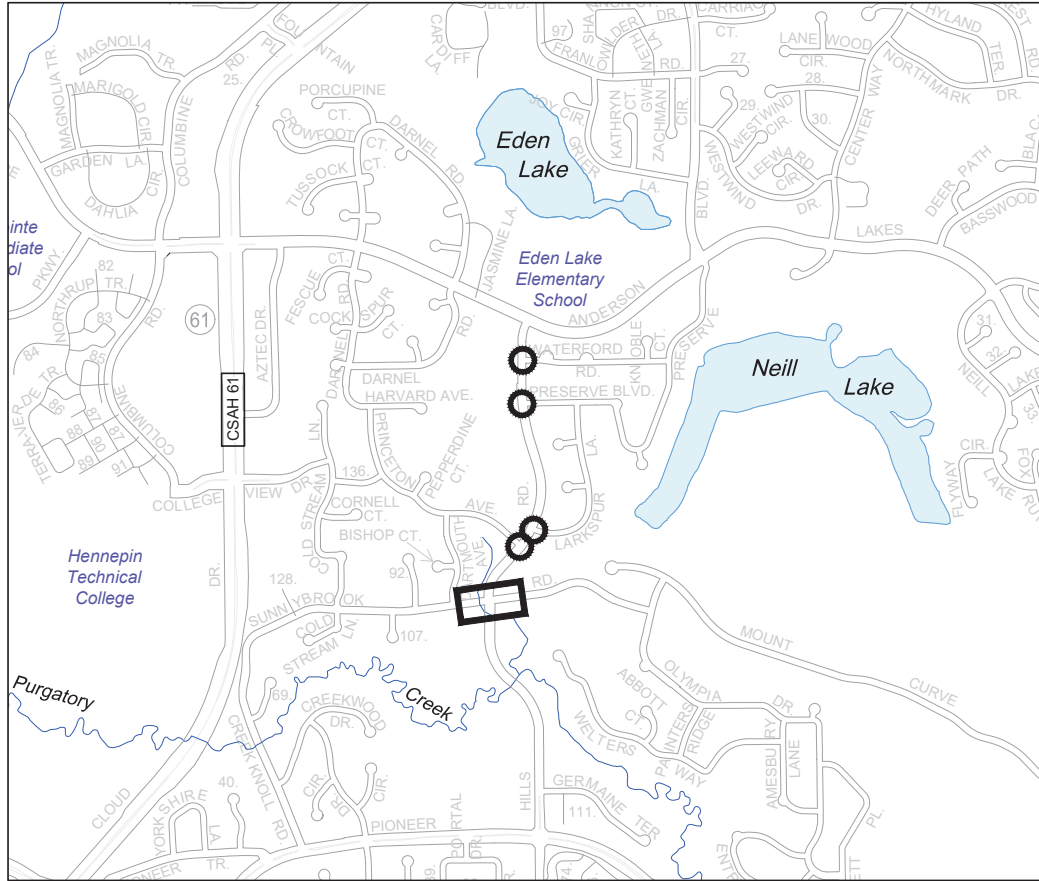

## GOVERNING SPECIFICATIONS

THE 2020 EDITION OF THE MINNESOTA DEPARTMENT OF TRANSPORTATION "STANDARD SPECIFICATIONS FOR CONSTRUCTION" SHALL GOVERN.

ALL TRAFFIC CONTROL DEVICES SHALL CONFORM AND BE INSTALLED IN ACCORDANCE TO THE "MINNESOTA MANUAL ON UNIFORM TRAFFIC CONTROL DEVICES" (MUTCD) AND PART VI, "FIELD MANUAL FOR TEMPORARY TRAFFIC CONTROL ZONE LAYOUTS".

THE SUBSURFACE UTILITY INFORMATION IN THIS PLAN IS UTILITY QUALITY LEVEL D. THIS QUALITY LEVEL WAS DETERMINED ACCORDING TO GUIDELINES OF CVA/SCE 38-02, ENTITLED "STANDARD GUIDELINES FOR THE COLLECTION AND DEPICTION OF EXISTING SUBSURFACE UTILITY DATA."

## INDEX

Sheet No.	Sheet Name
1	COVER SHEET
2	EROSION CONTROL & GENERAL NOTES, SEQ & DETAILS
3-4	ADA PEDESTRIAN CURB RAMP PLANS
5-6	CITY DETAILS
7	EXISTING CONDITIONS AND REMOVALS PLAN
8	STORM SEWER PLAN AND EROSION CONTROL PLAN
9	STORM SEWER PROFILES
10-12	PAVEMENT & ADA PEDESTRIAN RAMP PLANS

THIS PLAN CONTAINS 12 SHEETS  
 THIS IS A 11X17 SET OF PLANS  
 THE DATUM ON THIS SET OF PLANS IS NAVD88

## REVISIONS

REV NO.	DATE	REVISION
1	3/7/2023	WATERSHED COMMENTS

THIS PLAN AND/OR SPECIFICATIONS WAS PREPARED SPECIFICALLY FOR THIS PROJECT, AND ANY RE-USE OF DETAILS OR SPECIFICATIONS ON OTHER PROJECTS IS NOT INTENDED OR AUTHORIZED BY THE DESIGNER. LIABILITY FOR ANY RE-USE ON OTHER PROJECTS IS THE RESPONSIBILITY OF THE PERSON, AGENCY, OR CORPORATION USING THIS PLAN OR SPECIFICATION DATA FROM THIS PROJECT.



I HEREBY CERTIFY THAT THIS PLAN WAS PREPARED BY ME OR UNDER MY DIRECT SUPERVISION AND THAT I AM A DULY LICENSED PROFESSIONAL ENGINEER UNDER THE LAWS OF THE STATE OF MINNESOTA.

SIGNATURE \_\_\_\_\_

PRINT NAME \_\_\_\_\_ PATRICK J. SEJKORA \_\_\_\_\_

DATE 03/07/2023 LICENSE NO. 53713 \_\_\_\_\_

SHEET NO. 1 OF 12 SHEETS



Know what's below.  
 Call before you dig.



PROJECT LOCATION  
 COUNTY: HENNEPIN  
 DISTRICT: METRO

**EROSION CONTROL NOTES**

- EXISTING CONDITIONS DATA IS COMPILED FROM A COMBINATION OF SURVEY, LIDAR, AERIAL PHOTOGRAPHY, GIS RECORDS, AND AS-BUILT CONSTRUCTION PLANS. ALL DATA SHOULD BE FIELD VERIFIED PRIOR TO CONSTRUCTION.
- THE INTENDED SEQUENCING OF MAJOR CONSTRUCTION ACTIVITIES ARE AS FOLLOWS:
  - INSTALL SEDIMENT CONTROL DEVICES
  - STRIP AND STOCKPILE TOPSOIL
  - INSTALL STORM SEWER
  - ROUGH GRADE SITE
  - FINAL GRADE SITE, RESPIRED MINIMUM SIX (6) INCHES OF TOPSOIL WITH A MINIMUM ORGANIC CONTENT OF 5%
  - REMOVE ACCUMULATED SEDIMENT FROM STORMWATER BMPs
  - SEED AND MULCH
  - WHEN ALL CONSTRUCTION ACTIVITY IS COMPLETE AND THE SITE IS STABILIZED, REMOVE SILT FENCE AND RESEED ANY AREAS DISTURBED BY THE REMOVAL.
- DISTURBED AREAS SHOULD BE SEEDED AS NOTED ON THE PLAN AND BY THE FOLLOWING METHODS:
  - SEED MIXTURE 33-261 (35 LBIAC)
  - SEED MIXTURE 35-241 (36.5 LBIAC)
  - TURF SEED, HYDROSEED, FERTILIZER
- ON SLOPES 3:1 OR GREATER MAINTAIN SHEET FLOW AND MINIMIZE RILLS AND/OR GULLIES. SLOPE LENGTHS CAN NOT BE GREATER THAN 75 FEET.
- ALL STORM DRAINS AND INLETS MUST BE PROTECTED UNTIL ALL SOURCES OF POTENTIAL DISCHARGE ARE STABILIZED.
- TEMPORARY SOIL STOCKPILES MUST HAVE EFFECTIVE SEDIMENT CONTROL AND CAN NOT BE PLACED IN SURFACE WATERS, WETLANDS, OR STORM WATER CONVEYANCE SYSTEMS. TEMPORARY STOCKPILES WITHOUT SIGNIFICANT AMOUNT OF SILT, CLAY, OR ORGANIC COMPOUNDS ARE EXEMPT EX. CLEAN AGGREGATE STOCK PILES, DEMOLITION CONCRETE STOCKPILES, SAND STOCKPILES.
- SEDIMENT LADEN WATER MUST BE DISCHARGED TO A SEDIMENTATION BASIN WHENEVER POSSIBLE. IF NOT POSSIBLE, IT MUST BE TREATED WITH THE APPROPRIATE BMPs.
- EXTERNAL WASHING OF CONSTRUCTION VEHICLES MUST BE LIMITED TO A DEFINED AREA OF THE SITE. RUNOFF MUST BE PROPERLY CONTAINED.
- NO ENGINE DEGREASING IS ALLOWED ON SITE.
- INSPECTIONS
  - INITIAL INSPECTION FOLLOWING SEDIMENT CONTROL BMP INSTALLATION BY CITY REPRESENTATIVE IS REQUIRED.
  - EXPOSED SOIL AREAS: ONCE EVERY 7 DAYS AND WITHIN 24 HOURS FOLLOWING A 0.5" OVER 24 HOUR RAIN EVENT.
  - STABILIZED AREAS: ONCE EVERY 30 DAYS
  - FROZEN GROUND: AS SOON AS RUNOFF OCCURS OR PRIOR TO RESUMING CONSTRUCTION.
- MINIMUM MAINTENANCE
  - SEDIMENT CONTROL BMPs TO BE REPAIRED, REPLACED, SUPPLEMENTED WHEN NONFUNCTIONAL OR 1/3 FULL, WITHIN 24 HOURS
  - CONSTRUCTION SITE EXITS INSPECTED, TRACKED SEDIMENT REMOVED WITH 24 HOURS.
  - EROSION INSPECTION RESULTS FOR ALL EVENTS GREATER THAN 1/2" IN 24 HOURS TO BE REVIEWED BY CITY DURING PROJECT INSPECTIONS.
- A CONCRETE WASHOUT AREA MUST BE PROVIDED.
- FINAL STABILIZATION: FINAL STABILIZATION REQUIRES THAT ALL SOIL DISTURBING ACTIVITIES HAVE BEEN COMPLETED AND THAT DISTURBED AREAS ARE STABILIZED BY A UNIFORM PERENNIAL VEGETATIVE COVER WITH 70% OF THE EXPECTED FINAL DENSITY, AND THAT ALL PERMANENT PAVEMENTS HAVE BEEN INSTALLED. ALL TEMPORARY BMPs SHALL BE REMOVED, DITCHES STABILIZED, AND SEDIMENT SHALL BE REMOVED FROM PERMANENT CONVEYANCES AND SEDIMENTATION BASINS IN ORDER TO RETURN THE POND TO DESIGN CAPACITY.
- ALL NONFUNCTIONAL BMPs SHALL BE REPAIRED, REPLACED OR SUPPLEMENTED WITHIN 24 HOURS.
- DISCHARGE OF SEDIMENT-LADEN OR POLLUTED WATER FROM THE PROJECT IS PROHIBITED. PRIOR TO DISCHARGE, WATER MUST FIRST BE FILTERED OR OTHERWISE TREATED TO REMOVE SEDIMENT AND POLLUTANTS. DISCHARGES MUST NOT CAUSE EROSION OR SCOUR, RESULT IN A NUISANCE CONDITION, OR CAUSE NEGATIVE IMPACTS TO ADJACENT PROPERTIES OR DOWNSTREAM WATERWAYS OR WATER RESOURCES.
- HAZARDOUS MATERIALS SHALL BE PROPERLY CONTAINED TO PREVENT SPILLS/LEAKS AND SHALL HAVE RESTRICTED ACCESS.
- SPILL PREVENTION AND RESPONSE MATERIALS SHALL BE AVAILABLE ON-HAND. SPILLS/LEAKS/DISCHARGES SHALL BE CONTAINED, DOCUMENTED, REPORTED AND RECOVERED IN ACCORDANCE WITH ALL APPLICABLE LAWS AND LOCAL/STATE REQUIREMENTS.
- CATEGORY 25 EROSION CONTROL BLANKET MUST BE INSTALLED WITHIN 48 HOURS OF COMPLETION OF GRADING.

**RPCVD EROSION CONTROL NOTES**

- NATURAL TOPOGRAPHY AND SOIL CONDITIONS MUST BE PROTECTED, INCLUDING RETENTION ONSITE OF NATIVE TOPSOIL TO THE GREATEST EXTENT POSSIBLE.
- ADDITIONAL MEASURES, SUCH AS HYDRAULIC MULCHING AND OTHER PRACTICES AS SPECIFIED BY THE DISTRICT MUST BE USED ON SLOPES OF 3:1 (H:V) OR STEEPER TO PROVIDE ADEQUATE STABILIZATION.
- FINAL SITE STABILIZATION MEASURES MUST SPECIFY THAT AT LEAST SIX (6) INCHES OF TOPSOIL OR ORGANIC MATTER BE SPREAD AND INCORPORATED INTO THE UNDERLYING SOIL DURING FINAL SITE TREATMENT WHEREVER TOPSOIL HAS BEEN REMOVED.
- CONSTRUCTION SITE WASTE SUCH AS DISCARDED BUILDING MATERIALS, CONCRETE TRUCK WASHOUT, CHEMICALS, LITTER AND SANITARY WASTE MUST BE PROPERLY MANAGED.
- ALL TEMPORARY EROSION AND SEDIMENT CONTROL BMPs MUST BE MAINTAINED UNTIL COMPLETION OF CONSTRUCTION AND VEGETATION IS ESTABLISHED SUFFICIENTLY TO ENSURE STABILITY OF THE SITE, AS DETERMINED BY THE DISTRICT.
- ALL TEMPORARY EROSION AND SEDIMENT CONTROL BMPs MUST BE REMOVED UPON FINAL STABILIZATION.
- SOIL SURFACES COMPACTED DURING CONSTRUCTION AND REMAINING PERVIOUS UPON COMPLETION OF CONSTRUCTION MUST BE DECOMPACTED TO ACHIEVE A SOIL COMPACTION TESTING PRESSURE OF LESS THAN 1,400 KILOPASCALS OR 200 POUNDS PER SQUARE INCH IN THE UPPER 12 INCHES OF THE SOIL PROFILE WHILE TAKING CARE TO PROTECT UTILITIES, TREE ROOTS, AND OTHER EXISTING VEGETATION.
- ALL DISTURBED AREAS MUST BE STABILIZED WITHIN 7 CALENDAR DAYS AFTER LAND-DISTURBING WORK HAS TEMPORARILY OR PERMANENTLY CEASED ON A PROPERTY THAT DRAINS TO AN IMPAIRED WATER, WITHIN 14 DAYS ELSEWHERE.
- THE PERMITTEE MUST, AT A MINIMUM, INSPECT, MAINTAIN AND REPAIR ALL DISTURBED SURFACES AND ALL EROSION AND SEDIMENT CONTROL FACILITIES AND SOIL STABILIZATION MEASURE EVERY DAY WORK IS PERFORMED ON THE SITE AND AT LEAST WEEKLY UNTIL LAND-DISTURBING ACTIVITY AS CEASED. THEREAFTER, THE PERMITTEE MUST PERFORM THESE RESPONSIBILITIES AT LEAST WEEKLY UNTIL VEGETATIVE COVER IS ESTABLISHED. THE PERMITTEE WILL MAINTAIN A LOG OF ACTIVITIES UNDER THIS SECTION FOR INSPECTION BY THE DISTRICT.
- ACTIVITIES MUST BE CONDUCTED SO AS TO MINIMIZE THE POTENTIAL TRANSFER OF AQUATIC INVASIVE SPECIES (E.G. ZEBRA MUSSELS, EURASIAN WATERMILFOL, ETC.) TO THE MAXIMUM EXTENT POSSIBLE.

**STATEMENT OF ESTIMATED QUANTITIES**

ITEM NO.	ITEM DESCRIPTION	UNIT	QUANTITY	ENGINEERS ESTIMATE
1	Mobilization	LS	1	1
2	Clearing & Grubbing	LS	1	1
3	Pavement Marking Removal	SF	141	141
4	Remove Manhole	EA	2	2
5	Remove Catchbasin	EA	1	1
6	Remove Flared End Section	EA	3	3
7	Remove Storm Sewer Pipe	LF	141	141
8	Remove Curb & Gutter	LF	291	291
9	Remove Bituminous Pavement	SY	826	826
10	Remove Bituminous Pavement (Trail)	SY	73	73
11	Remove Concrete Walk	SF	398	398
12	Sawing Bituminous Pavement (Full Depth)	LF	478	478
13	Sawing Concrete Pavement (Full Depth)	LF	35	35
14	Common Excavation	CY	500	500
15	Organic Topsoil Borrow	CY	23	23
16	Connect to Existing Structure	EA	2	2
17	Connect to Existing Pipe	EA	2	2
18	Round Manhole	EA	2	2
19	Manhole w/ Sump	EA	2	2
20	CASTING ASSEMBLY TYPE R-1733	EA	2	2
21	CASTING ASSEMBLY TYPE R-3067	EA	2	2
22	24" Elliptical Flared End Section / Pipe Apron	EA	1	1
23	24" Flared End Section / Pipe Apron	EA	1	1
24	18" Flared End Section / Pipe Apron	EA	1	1
25	24" Elliptical Class V RCP Pipe	LF	62	62
26	24" Class V RCP Pipe	LF	9	9
27	18" HDPE Pipe	LF	34	34
28	15" HDPE Pipe	LF	6	6
29	15" Class V RCP Pipe	LF	30	30
30	6" Perforated Drain tile	LF	61	61
31	Cleanout	EA	1	1
32	Select Granular Fill (CV)	CY	321	321
33	Aggregate Base C15 (CV)	CY	170	170
34	1.5" Bituminous Wear Course - SPWEA240C	TON	44	44
35	Bituminous Non-Wear Course - SPWNB230C	TON	59	59
36	5" Concrete Walk	SF	1175	1175
37	Concrete Curb & Gutter (B618)	LF	291	291
38	Truncated Domes	SF	226	226
39	Install Sign (Buffer Monuments)	EA	2	2
40	Traffic Control	LS	1	1
41	Crosswalk Multi-Comp - 24" White	SF	432	432
42	Floating Silt Curtain	LF	27	27
43	Biolog or Approved Equal	LF	125	125
44	Inlet Protection	EA	12	12
45	Geotextile Fabric (under Riprap)	SY	50	50
46	24" Depth Riprap Class II	CY	15	15
47	MnDOT Seed Mix 35-241	LB	1	1
48	MnDOT Seed Mix 33-261	LB	1	1
49	Erosion Control Blanket Cat 10	SY	37	37
50	Turf Establishment	LS	1	1
51	Sweeping	HR	8	8

**DISTURBED AREAS**

TOTAL AREA DISTURBED 6,291 sf  
TOTAL IMPERVIOUS RECONSTRUCTED 5,957 sf



Know what's below.  
Call before you dig.

I hereby certify that this plan, specification, or report was prepared by me or under my direct supervision and that I am a duly Licensed Professional Engineer under the laws of the State of Minnesota.  
Print Name: PATRICK J. SEJKORA  
Date: 03/07/2023 License #: 53713

**GENERAL NOTES**

- CONTRACTOR SHALL REMOVE ALL LANDSCAPING WITHIN REMOVAL AREA. CONTRACTOR SHALL PROTECT EXISTING VEGETATION AND SITE FEATURES, WHICH ARE TO REMAIN, WITH APPROVED METHODS AND MATERIALS. ALL SITE FEATURES DAMAGED BY CONTRACTOR THAT ARE NOT DESIGNATED FOR REMOVAL SHALL BE REPAIRED/REPLACED BY CONTRACTOR AT THEIR OWN EXPENSE.
- CONTRACTOR SHALL FIELD VERIFY THE LOCATIONS AND ELEVATIONS OF EXISTING UTILITIES AND TOPOGRAPHIC FEATURES PRIOR TO THE START OF SITE GRADING.
- CONTRACTOR TO NOTIFY THE ENGINEER IMMEDIATELY OF ANY DISCREPANCIES OR VARIATIONS FROM THE PLANS.
- UTILITIES NOT MARKED FOR REMOVAL SHALL BE PROTECTED FROM DAMAGE DURING CONSTRUCTION.
- SITE BOUNDARY, TOPOGRAPHY, UTILITY AND ROAD INFORMATION TAKEN FROM AERIAL PHOTOGRAPHY & GIS DATA. ALL LOCATIONS OF EXISTING FEATURES SHALL BE VERIFIED PRIOR TO CONSTRUCTION.
- THE CONTRACTOR IS SPECIFICALLY CAUTIONED THAT THE LOCATION AND/OR ELEVATION OF EXISTING UTILITIES AS SHOWN ON THESE PLANS IS BASED ON RECORDS OF THE VARIOUS UTILITY COMPANIES, AND WHERE POSSIBLE, MEASUREMENTS TAKEN IN THE FIELD. THE INFORMATION IS NOT TO BE RELIED ON AS BEING EXACT OR COMPLETE. THE CONTRACTOR MUST CALL THE APPROPRIATE UTILITY COMPANIES AT LEAST 72 HOURS BEFORE ANY EXCAVATION TO REQUEST EXACT FIELD LOCATION OF UTILITIES. IT SHALL BE THE RESPONSIBILITY OF THE CONTRACTOR TO RELOCATE ALL EXISTING UTILITIES WHICH CONFLICT WITH THE PROPOSED IMPROVEMENTS SHOWN ON THE PLANS.
- SIDEWALK CROSS SLOPES SHALL NOT EXCEED 2.0%. LENGTH OF RAMP VARIES BASED ON SPECIFIC SITE GRADINGS. CONTRACTOR TO VERIFY ELEVATIONS TO ENSURE ADA GUIDELINES ARE MET. SEE MNDOT STANDARD PLANS, SHEETS 3 & 4.
- CONTRACTOR SHALL VERIFY PROPOSED PLAN WITH FIELD CONDITIONS TO ENSURE DESIGN MEETS VARIOUS GUIDELINES.
- PROPOSED QUANTITY FOR TRUNCATED DOMES IS AN ESTIMATE AND SHOULD BE VERIFIED BY THE CONTRACTOR IN THE FIELD PRIOR TO ORDERING MATERIALS (SEE MNDOT STANDARD PLAN 7038A).
- CURB TRANSITIONS PAID FOR UNDER CURB & GUTTER.
- CONTRACTOR TO PROVIDE A BITUMINOUS PATCH Z IN WIDTH IN FRONT OF AND FOR THE LENGTH OF THE CURB REPLACEMENT. BITUMINOUS PATCH AREAS TO BE SAWCUT (FULL DEPTH).

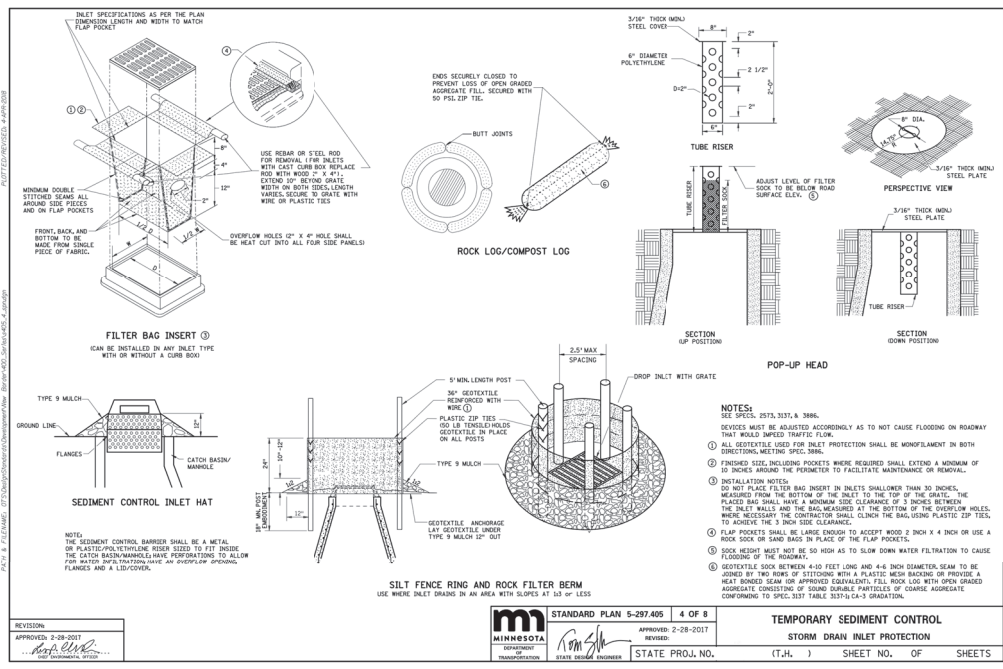
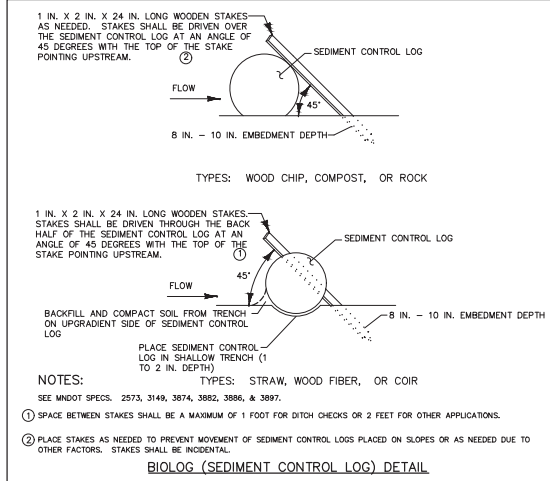

G:\Engineering\2023\ACTIVE\Eden Prairie\Sunnybrook Culvert Replacement\06 Design\CAD\2 EC Notes, Details & SEC.dwg

CITY PROJECT NO. 23809  
DRAWN BY MLS  
DESIGNED BY MSL  
CHECKED BY PJS  
DATE: 02/14/23



CITY OF EDEN PRAIRIE  
SUNNYBROOK CULVERT REPLACEMENT & ADA PEDESTRIAN RAMP PROJECT  
EROSION CONTROL & GENERAL NOTES, SEQ & DETAILS

SHEET 2 OF 12

**PERPENDICULAR**  
FRONT OF GUTTER  
BACK OF CURB  
FLOW LINE  
FLARE

**TAPERED PERPENDICULAR**  
NON-WALKABLE OR WALKABLE SURFACE  
NON-WALKABLE OR WALKABLE SURFACE

**PARALLEL**  
CURB OR CURB AND GUTTER  
FRONT OF GUTTER  
BACK OF CURB  
FLOW LINE  
FLARE

**DEPRESSED CORNER**  
CURB OR CURB AND GUTTER  
FRONT OF GUTTER  
BACK OF CURB  
FLOW LINE  
FLARE

**SECTION A-A**  
PERPENDICULAR/TIERED/DIAGONAL  
FRONT OF GUTTER  
BACK OF CURB  
FLOW LINE  
FLARE

**SECTION B-B**  
FAN  
FRONT OF GUTTER  
BACK OF CURB  
FLOW LINE  
FLARE

**SECTION C-C**  
PARALLEL/DEPRESSED CORNER  
FRONT OF GUTTER  
BACK OF CURB  
FLOW LINE  
FLARE

**SECTION D-D**  
CURB FOR DIRECTIONAL RAMPS

**NOTES**

**LEGEND**

**REVISIONS**

**MINNESOTA STANDARD PLAN 5-297.250 1 OF 6 PEDESTRIAN CURB RAMP DETAILS**  
APPROVED: 11-04-2021  
STATE PROJ. NO. (T.H.) SHEET NO. OF SHEETS

**COMBINED DIRECTIONAL**  
FRONT OF GUTTER  
BACK OF CURB  
FLOW LINE  
FLARE

**ONE-WAY DIRECTIONAL WITH DETECTABLE WARNING AT BACK OF CURB**  
FRONT OF GUTTER  
BACK OF CURB  
FLOW LINE  
FLARE

**SEMI-DIRECTIONAL RAMP**  
FRONT OF GUTTER  
BACK OF CURB  
FLOW LINE  
FLARE

**NOTES**

**LEGEND**

**REVISIONS**

**MINNESOTA STANDARD PLAN 5-297.250 2 OF 6 PEDESTRIAN CURB RAMP DETAILS**  
APPROVED: 11-04-2021  
STATE PROJ. NO. (T.H.) SHEET NO. OF SHEETS

**PERPENDICULAR**  
FRONT OF GUTTER  
BACK OF CURB  
FLOW LINE  
FLARE

**NON PERPENDICULAR**  
FRONT OF GUTTER  
BACK OF CURB  
FLOW LINE  
FLARE

**OUTFLOW GUTTER**  
FRONT OF GUTTER  
BACK OF CURB  
FLOW LINE  
FLARE

**ADA CURB EXTENSION WITH COMPOUND RADIUS (BUMP OUT)**  
FRONT OF GUTTER  
BACK OF CURB  
FLOW LINE  
FLARE

**PAVEMENT TREATMENT OPTIONS IN FRONT OF CURB & GUTTER**  
FRONT OF GUTTER  
BACK OF CURB  
FLOW LINE  
FLARE

**COMBINED DIRECTIONAL (COMPOUND RADIUS)**  
FRONT OF GUTTER  
BACK OF CURB  
FLOW LINE  
FLARE

**NOTES**

**REVISIONS**

**MINNESOTA STANDARD PLAN 5-297.250 3 OF 6 PEDESTRIAN CURB RAMP DETAILS**  
APPROVED: 11-04-2021  
STATE PROJ. NO. (T.H.) SHEET NO. OF SHEETS

**DETECTABLE EDGE WITH CURB AND GUTTER**  
FRONT OF GUTTER  
BACK OF CURB  
FLOW LINE  
FLARE

**TYPICAL SIDE TREATMENT OPTIONS**  
FRONT OF GUTTER  
BACK OF CURB  
FLOW LINE  
FLARE

**RAILROAD CROSSING PLAN VIEW**  
FRONT OF GUTTER  
BACK OF CURB  
FLOW LINE  
FLARE

**NOTES**

**REVISIONS**

**MINNESOTA STANDARD PLAN 5-297.250 4 OF 6 PEDESTRIAN CURB RAMP DETAILS**  
APPROVED: 11-04-2021  
STATE PROJ. NO. (T.H.) SHEET NO. OF SHEETS

1	03/07/2023	AAK	AAK	PJS	WATERSHED COMMENTS
NO	DATE	BY	CHKD	APPR	REVISION

I hereby certify that this plan, specification, or report was prepared by me or under my direct supervision and that I am a duly Licensed Professional Engineer under the laws of the State of Minnesota.  
Print Name: PATRICK J. SEJKORA  
Date: 03/07/2023 License # 53713

CITY PROJECT NO. 23809  
DRAWN BY MLS  
DESIGNED BY MSL  
CHECKED BY PJS  
DATE: 02/10/23



CITY OF EDEN PRAIRIE  
SUNNYBROOK CULVERT REPLACEMENT & ADA PEDESTRIAN RAMP PROJECT  
ADA PEDESTRIAN CURB RAMP DETAILS

G:\Engineering\Civil\ACTIVE\Eden Prairie\Sunnbrook Culvert Replacement\06 Design\CAD\2 EC Notes, Details & SEC.dwg

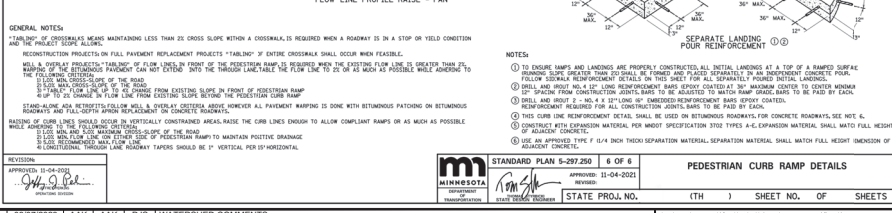
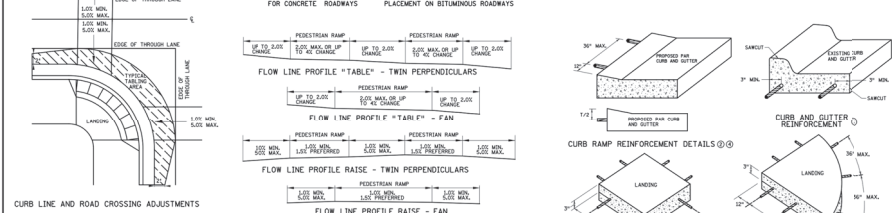
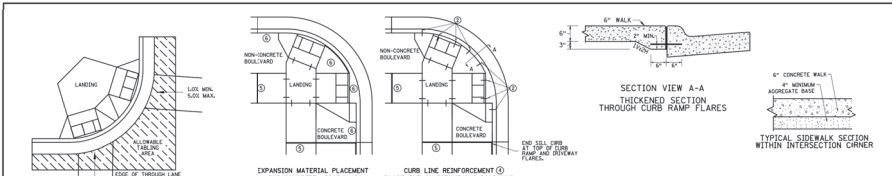
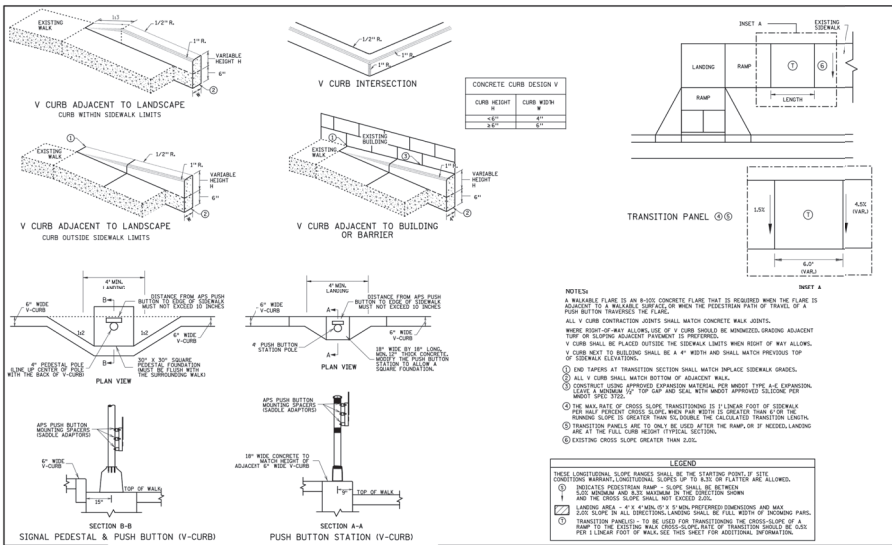

REVISION:	APPROVED: 11-04-2021	MINNESOTA PROFESSIONAL ENGINEER	STATE PROJ. NO.	17H	SHEET NO. OF SHEETS	5 OF 6
<p>I hereby certify that this plan, specification, or report was prepared by me or under my direct supervision and that I am a duly Licensed Professional Engineer under the laws of the State of Minnesota.</p> <p>Print Name: <b>PATRICK J. SEJKORA</b></p> <p>Date: <b>03/07/2023</b> License # <b>53713</b></p>						

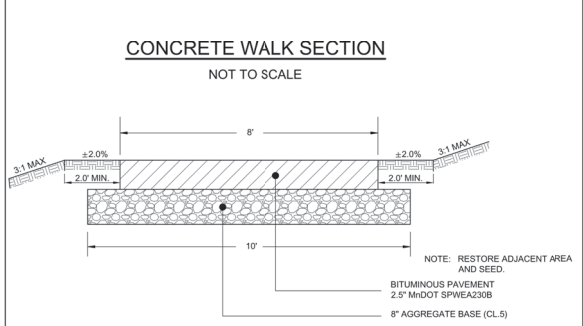
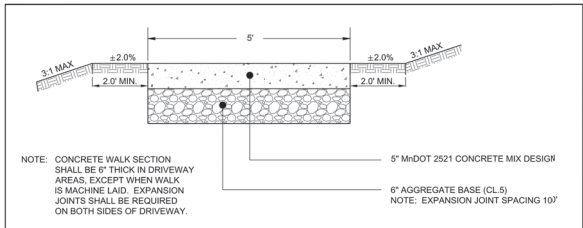

**TYPICAL WALKWAY SECTION**

CITY OF EDEN PRAIRIE  
DEPARTMENT OF ENGINEERING

REV 01/16/2019  
DETAIL NO.  
**R-16**

**EDEN PRAIRIE PUBLIC WORKS**

8080 MITCHELL ROAD, EDEN PRAIRIE, MN  
PHONE: (952) 948-6300

CITY PROJECT NO. 23809	DRAWN BY MLS DESIGNED BY MLS CHECKED BY PJS DATE: 02/14/23	CITY OF EDEN PRAIRIE SUNNBROOK CULVERT REPLACEMENT & ADA PEDESTRIAN RAMP DETAILS & TYPICAL WALKWAY SECTION	SHEET 4 OF 12
---------------------------	--	---	------------------------

**STANDARD CATCH BASIN**  
CITY OF EDEN PRAIRIE  
DEPARTMENT OF ENGINEERING

DETAIL NO. **S-5**

REV 03/15/2022

**SUMP MANHOLE OR CATCH BASIN**  
CITY OF EDEN PRAIRIE  
DEPARTMENT OF ENGINEERING

DETAIL NO. **S-7**

REV 03/16/2023

**STANDARD SUBSURFACE EDGE DRAINS RETROFIT & NEW ROAD**  
CITY OF EDEN PRAIRIE  
DEPARTMENT OF ENGINEERING

DETAIL NO. **S-10**

Rev. 03/16/2022

**RESIDENTIAL COLLECTOR SECTION**  
CITY OF EDEN PRAIRIE  
DEPARTMENT OF ENGINEERING

DETAIL NO. **R-3**

Rev. 03/15/2022

**TRASH GUARD FOR CONCRETE APRONS**  
CITY OF EDEN PRAIRIE  
DEPARTMENT OF ENGINEERING

DETAIL NO. **S-11**

REV 03/01/2013

Approx. Size	V-bar Size	H-bar Size	No. of V-bars	Bolt Size	"A" Dim.
11 1/2" x 4"	3/8"	3/8"	3	3/8"	4
11 1/2" x 4 1/2"	3/8"	3/8"	3	3/8"	4 1/2
11 1/2" x 5"	3/8"	3/8"	4	3/8"	4 1/2
21 1/2" x 4"	3/8"	3/8"	4	3/8"	5
21 1/2" x 4 1/2"	3/8"	3/8"	4	3/8"	5 1/2
21 1/2" x 5"	3/8"	3/8"	4	3/8"	5
31 1/2" x 4"	3/8"	3/8"	4	3/8"	8
31 1/2" x 4 1/2"	3/8"	3/8"	4	3/8"	8
31 1/2" x 5"	3/8"	3/8"	4	3/8"	8
41 1/2" x 4"	3/8"	3/8"	4	3/8"	8
41 1/2" x 4 1/2"	3/8"	3/8"	4	3/8"	8
41 1/2" x 5"	3/8"	3/8"	4	3/8"	8
51 1/2" x 4"	3/8"	3/8"	4	3/8"	8
51 1/2" x 4 1/2"	3/8"	3/8"	4	3/8"	8
51 1/2" x 5"	3/8"	3/8"	4	3/8"	8
61 1/2" x 4"	3/8"	3/8"	4	3/8"	8
61 1/2" x 4 1/2"	3/8"	3/8"	4	3/8"	8
61 1/2" x 5"	3/8"	3/8"	4	3/8"	8
71 1/2" x 4"	3/8"	3/8"	4	3/8"	8
71 1/2" x 4 1/2"	3/8"	3/8"	4	3/8"	8
71 1/2" x 5"	3/8"	3/8"	4	3/8"	8

REV 03/01/2013

**BEDDING FOR PVC, HDPE (ALL SIZES), AND RCP (8" AND LARGER)**  
CITY OF EDEN PRAIRIE  
DEPARTMENT OF ENGINEERING

DETAIL NO. **S-12**

REV. 03/15/2022

**TYPICAL MINIMUM ROADWAY SECTION**  
CITY OF EDEN PRAIRIE  
DEPARTMENT OF ENGINEERING

DETAIL NO. **R-1**

Rev. 02/07/2023

**B612, B618 & MOUNTABLE CURB & GUTTER**  
CITY OF EDEN PRAIRIE  
DEPARTMENT OF ENGINEERING

DETAIL NO. **R-9**

Rev. 03/16/2022

NO	DATE	BY	CHKD	APPR	REVISION
1	03/07/2023	AAK	AAK	PJS	WATERSHED COMMENTS

I hereby certify that this plan, specification, or report was prepared by me or under my direct supervision and that I am a duly Licensed Professional Engineer under the laws of the State of Minnesota.  
 Print Name: **PATRICK J. SEJKORA**  
 Date: **03/07/2023** License # **53713**

CITY PROJECT NO. **23809**  
 DRAWN BY **ML**  
 DESIGNED BY **MLS**  
 CHECKED BY **PJS**  
 DATE: **02/14/23**



CITY OF EDEN PRAIRIE  
**SUNNYBROOK CULVERT REPLACEMENT & ADA PEDESTRIAN RAMP PROJECT**  
 CITY DETAILS

G:\Engineering\City-Active\Foldes\23809 Sunnybrook Culvert Replacement\06 Design\CAD\2 EC Notes, Details & SEC.dwg

TABLE OF QUANTITIES  
RIPRAP AT RCP OUTLETS

DIA. OF ROUND PIPE (IN.)	L (FT.)	CLASS II d <sub>50</sub> = 6"			CLASS III d <sub>50</sub> = 9"			CLASS IV d <sub>50</sub> = 12"		
		GEO-TEXTILE FILTER (SQ. YD.)	GRANULAR FILTER UNDER APRON (CU. YD.)	12" DEPTH RIPRAP (CU. YD.)	GEO-TEXTILE FILTER (SQ. YD.)	GRANULAR FILTER UNDER APRON (CU. YD.)	18" DEPTH RIPRAP (CU. YD.)	GEO-TEXTILE FILTER (SQ. YD.)	GRANULAR FILTER UNDER APRON (CU. YD.)	24" DEPTH RIPRAP (CU. YD.)
12	8	16.9	0.2	3.0	19.6	0.3	4.4	22.6	0.3	5.9
15	8	18.0	0.2	3.2	20.8	0.3	4.8	23.9	0.4	6.4
18	10	22.4	0.3	4.3	25.6	0.4	6.4	29.0	0.5	8.5
21	10	24.1	0.4	4.7	27.4	0.6	7.1	30.9	0.7	9.4
24	12	29.7	0.5	6.2	33.4	0.8	9.2	37.3	1.0	12.3
27	12	31.4	0.6	6.6	35.2	0.9	9.9	39.2	1.2	13.2
30	14	37.4	0.8	8.2	41.6	1.1	12.3	46.0	1.5	16.4
36	16	45.9	1.1	10.6	50.5	1.6	15.8	55.4	2.1	21.1
42	18	52.8	1.2	12.5	57.8	1.7	18.7	63.0	2.3	24.9
48	20	61.1	1.5	14.8	66.5	2.2	22.2	72.0	2.9	29.6

TABLE OF QUANTITIES  
RIPRAP AT RCP-A OUTLETS

SPAN OF PIPE ARCH (IN.)	L (FT.)	CLASS II d <sub>50</sub> = 6"			CLASS III d <sub>50</sub> = 9"			CLASS IV d <sub>50</sub> = 12"		
		GEO-TEXTILE FILTER (SQ. YD.)	GRANULAR FILTER UNDER APRON (CU. YD.)	12" DEPTH RIPRAP (CU. YD.)	GEO-TEXTILE FILTER (SQ. YD.)	GRANULAR FILTER UNDER APRON (CU. YD.)	18" DEPTH RIPRAP (CU. YD.)	GEO-TEXTILE FILTER (SQ. YD.)	GRANULAR FILTER UNDER APRON (CU. YD.)	24" DEPTH RIPRAP (CU. YD.)
22	10	22.4	0.3	4.1	25.6	0.4	6.1	23.0	0.5	8.1
28	12	29.5	0.5	5.7	33.2	0.7	8.5	37.1	0.9	11.3
36	14	37.3	0.8	7.5	41.5	1.1	11.2	45.8	1.5	14.9
43	16	45.9	1.1	9.5	50.5	1.6	14.3	55.3	2.1	19.0
51	18	52.5	1.2	11.3	57.5	1.7	16.9	62.7	2.3	22.5
58	20	59.9	1.3	13.2	65.2	1.9	19.8	73.7	2.5	26.4

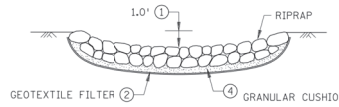
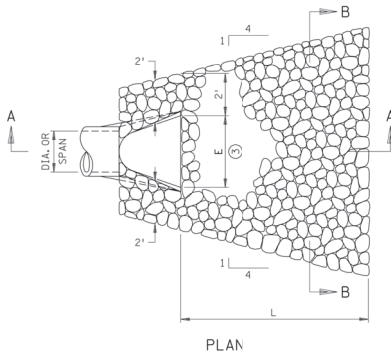

SECTION B-B

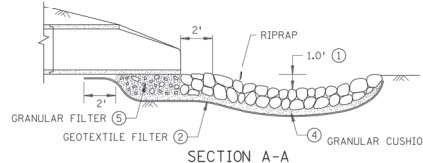

SECTION A-A

- NOTES:**  
 REQUIREMENTS FOR GEOTEXTILE TYPE, RIPRAP SIZE AND THICKNESS WILL BE DESIGNATED IN THE PLANS.  
 PIPE SIZES LARGER THAN THOSE SHOWN REQUIRE A SPECIAL DESIGN.
- ① FOR PIPES GREATER THAN OR EQUAL TO 30", USE 1.5".
  - ② GEOTEXTILE FILTER, SPEC. 3733, SHALL COVER THE BOTTOM AND SIDES OF THE AREA EXCAVATED FOR THE RIPRAP. GRANULAR FILTER MATERIALS.
  - ③ DIMENSION E IS GIVEN ON STANDARD PLATES 3100 AND 3110.
  - ④ GRANULAR FILTER, SPEC. 3601, MAY BE USED AS A CUSHION LAYER. PLACE FILTER PER SPEC. 2511. THE CUSHION LAYER IS INCIDENTAL.
  - ⑤ GRANULAR FILTER OR RIPRAP, SPEC. 3601, TO EXTEND UNDER ENTIRE OPEN PORTION OF PIPE APRON. DEPTH OF MATERIAL UNDER APRON SHALL MATCH RIPRAP DEPTH. WHEN USING RIPRAP INCREASE RIPRAP QUANTITY ACCORDINGLY AND PLACE A 3" LAYER OF 1.5" CRUSHED ROCK UNDER THE APRON TO AID IN GRADING FOR APRON PLACEMENT. CRUSHED ROCK IS INCIDENTAL.

APPROVED DECEMBER 9, 2013	STATE OF MINNESOTA DEPARTMENT OF TRANSPORTATION	SPECIFICATION REFERENCE	STANDARD PLATE NO.
<i>Christy L. By</i> STATE DESIGN ENGINEER	RIPRAP AT RCP OUTLETS	3100 3110 3601 3733 2511	3133D

FLUSH MOUNT BUFFER MARKER

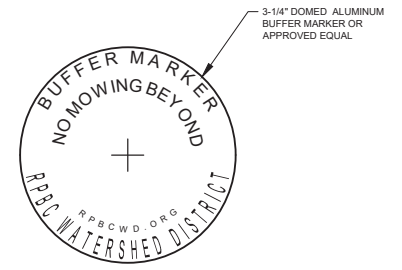

- NOTES**
1. BUFFER MARKER TO BE IDENTIFIED WITH A DURABLE MARKER OR CAP BEARING INFORMATION SHOWN ON DETAIL WITH A MINIMUM DIAMETER OF 3 INCHES.
  2. BUFFER MARKER TO BE COMPOSED OF A DURABLE MATERIAL.
  3. BUFFER MARKER TO BE DETECTABLE WITH CONVENTIONAL INSTRUMENTS FOR FINDING FERROUS OR MAGNETIC OBJECTS.
  4. BUFFER MARKER TO BE INSTALLED FLUSH TO THE GROUND SURFACE.
  5. BUFFER MARKER TO BE MOUNTED TO A BURIED PIECE OF REBAR WITH A MINIMUM LENGTH OF 18 INCHES AND A MINIMUM DIAMETER OF 1/2 INCH (#4 REBAR IS ACCEPTABLE).

1	03/07/2023	AAK	AAK	PJS	WATERSHED COMMENTS
NO	DATE	BY	CHKD	APPR	REVISION

I hereby certify that this plan, specification, or report was prepared by me or under my direct supervision and that I am a duly Licensed Professional Engineer under the laws of the State of Minnesota.  
 Print Name: PATRICK J. SEJKORA  
 Date: 03/07/2023 License #: 53713

CITY PROJECT NO. 23809  
 DRAWN BY: MLS  
 DESIGNED BY: MLS  
 CHECKED BY: PJS  
 DATE: 02/14/23



CITY OF EDEN PRAIRIE  
 SUNNYBROOK CULVERT REPLACEMENT & ADA PEDESTRIAN RAMP PROJECT  
 CITY DETAILS

SHEET 6 OF 12

G:\Engineering\2021\ACTIVE\Folders\33809 Sunnybrook Culvert Replacement\08 Design\CAD\Sunnybrook Culvert Replacement Plans.dwg

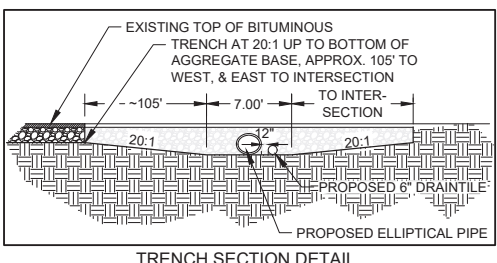
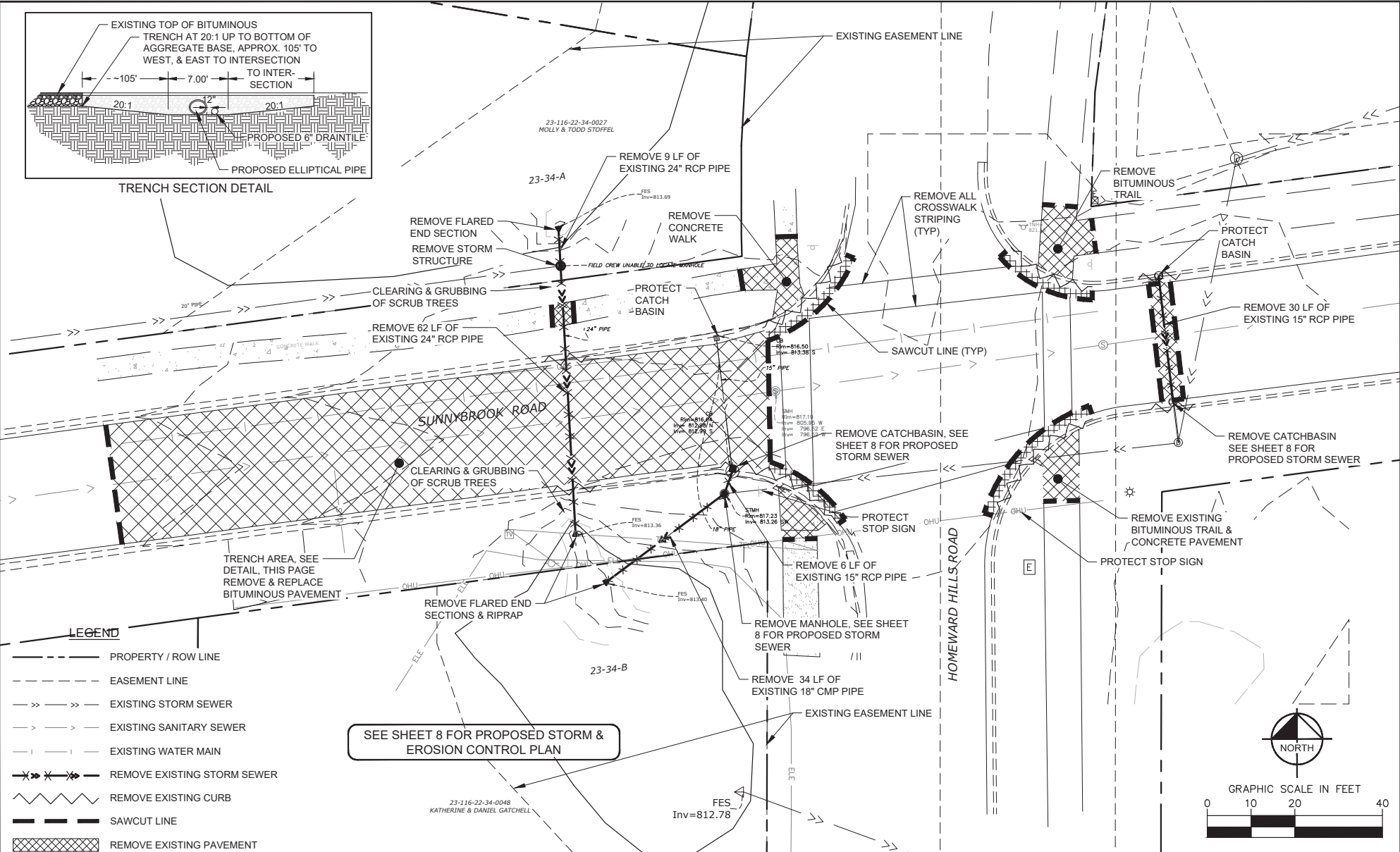

**LEGEND**

- PROPERTY / ROW LINE
- - - EASEMENT LINE
- >> - >> - EXISTING STORM SEWER
- > - > - EXISTING SANITARY SEWER
- - - - EXISTING WATER MAIN
- X - X - REMOVE EXISTING STORM SEWER
- / - / - REMOVE EXISTING CURB
- - - SAWCUT LINE
- XXXXX REMOVE EXISTING PAVEMENT

SEE SHEET 8 FOR PROPOSED STORM & EROSION CONTROL PLAN

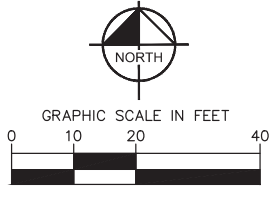

NO	DATE	BY	CHKD	APPR	REVISION
1	03/07/2023	AAK	AAK	PJS	WATERSHED COMMENTS

I hereby certify that this plan, specification, or report was prepared by me or under my direct supervision and that I am a duly Licensed Professional Engineer under the laws of the State of Minnesota.  
 Print Name: **PATRICK J. SEJKORA**  
 Date: **03/07/2023** License # **53713**

CITY PROJECT NO.  
**23809**

DRAWN BY  
 MLS  
 DESIGNED BY  
 MLS  
 CHECKED BY  
 PJS  
 DATE: 02/14/23



CITY OF EDEN PRAIRIE  
**SUNNYBROOK CULVERT REPLACEMENT & ADA PEDESTRIAN RAMP PROJECT**  
 EXISTING CONDITIONS AND REMOVALS PLAN

SHEET  
**7**  
 OF  
**12**



**LEGEND**

- PROPERTY / ROW LINE
- EXISTING CONTOURS
- >> EXISTING STORM SEWER
- > EXISTING SANITARY SEWER
- - - EXISTING WATER MAIN
- >> PROPOSED STORM SEWER
- - - PROPOSED DRAINTILE

- TURF ESTABLISHMENT AREAS
- FLOATING SILT CURTAIN (AS NEEDED)
- FLOW DIRECTION
- - - EASEMENT LINE
- ADDITIONAL BUFFER MONUMENTS

- PROPOSED FLARED END SECTION W/ RIP RAP
- PROPOSED FLARED END SECTION WITH INLET PROTECTION
- INLET PROTECTION
- BIOROLL
- MNDOT SEED MIX 35-241 (@36.5 LB/AC)  
CAT10 EROSION CONTROL BLANKET
- MNDOT SEED MIX 33-261 (@35 LB/AC)  
CAT 10 EROSION CONTROL BLANKET

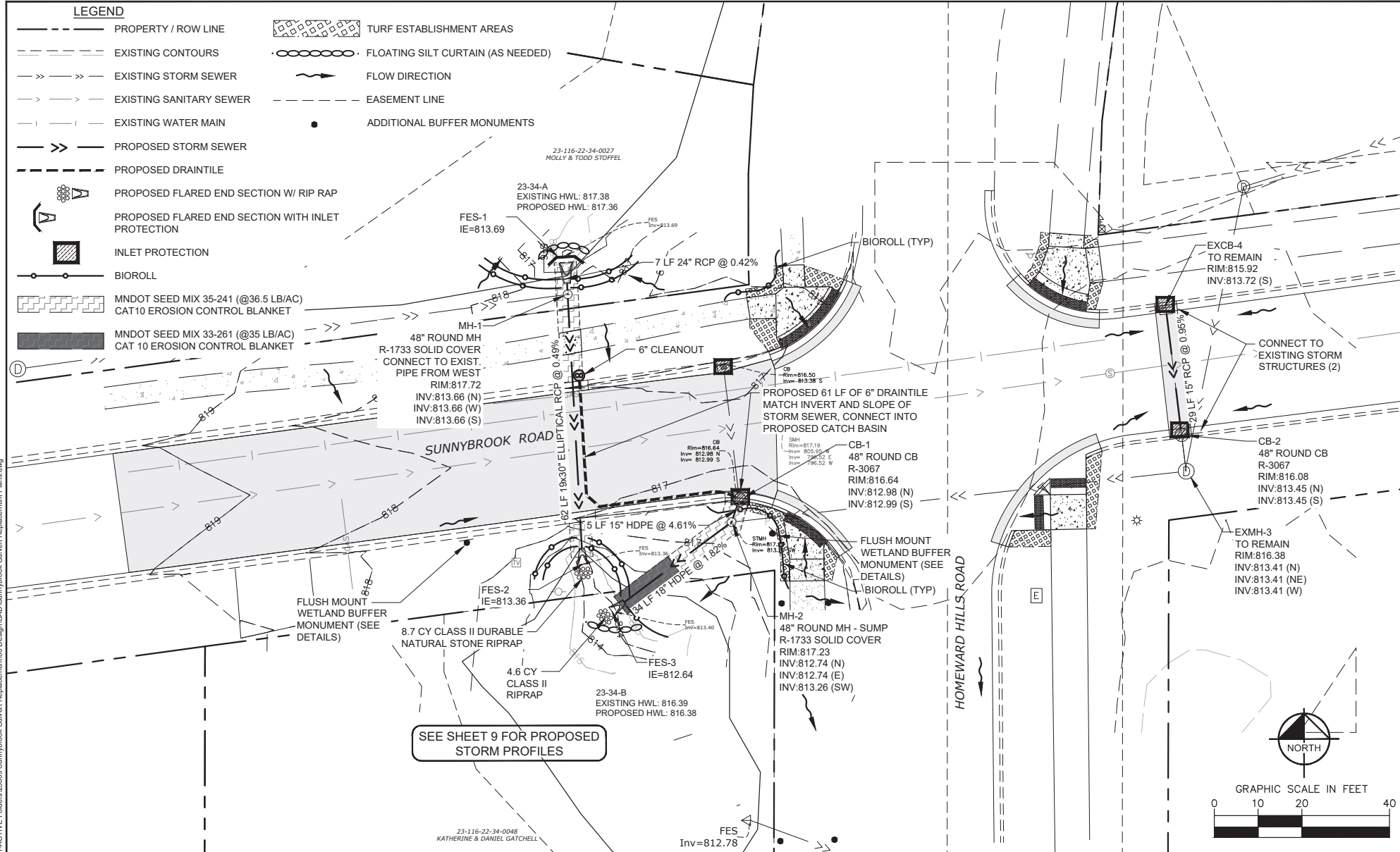

SEE SHEET 9 FOR PROPOSED STORM PROFILES

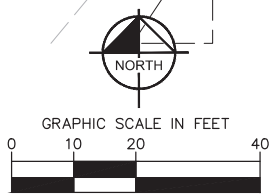

G:\Engineering\Civil\ACTIVE Folders\238109 Sunnybrook Culvert Replacement\08 Design\CAD\Sunnybrook Culvert Replacement Plans.dwg

NO	DATE	BY	CHKD	APPR	REVISION
1	03/07/2023	AAK	AAK	PJS	WATERSHED COMMENTS

I hereby certify that this plan, specification, or report was prepared by me or under my direct supervision and that I am a duly Licensed Professional Engineer under the laws of the State of Minnesota.  
 Print Name: **PATRICK J. SEJKORA**  
 Date: **03/07/2023** License # **53713**

CITY PROJECT NO.  
23809

DESIGNED BY  
MLS  
 CHECKED BY  
PJS  
 DATE: 02/14/23



CITY OF EDEN PRAIRIE  
 SUNNYBROOK CULVERT REPLACEMENT & ADA PEDESTRIAN RAMP PROJECT  
 STORM SEWER PLAN AND EROSION CONTROL PLAN

SHEET  
8  
OF  
12

SUNNYBROOK STORM SEWER IMPROVEMENTS

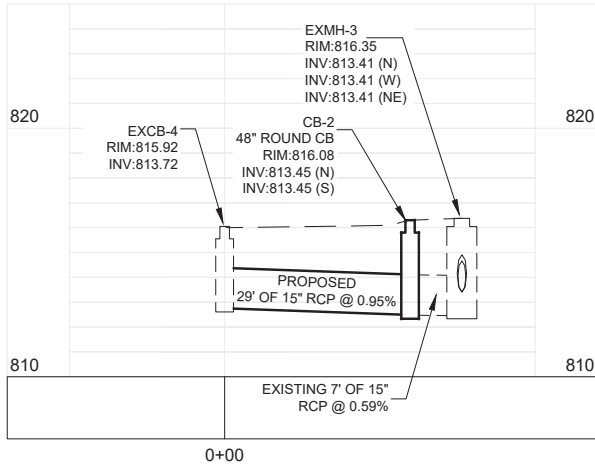

SUNNYBROOK STORM SEWER IMPROVEMENTS

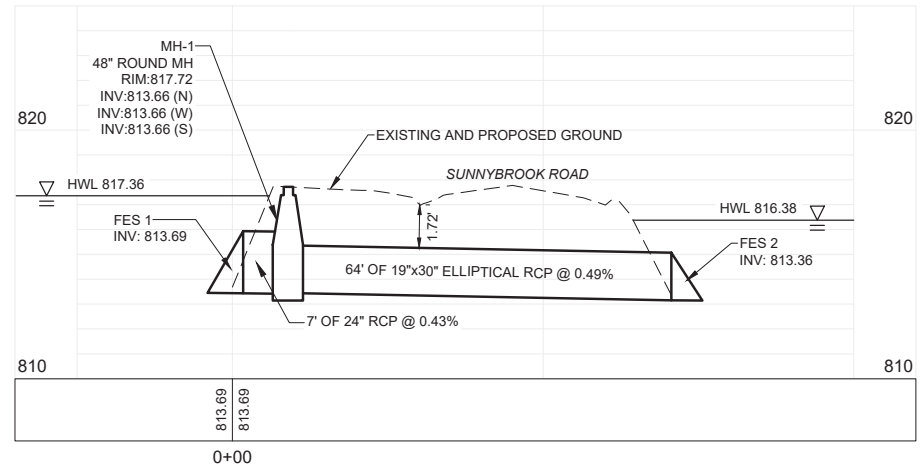

SUNNYBROOK STORM SEWER IMPROVEMENTS

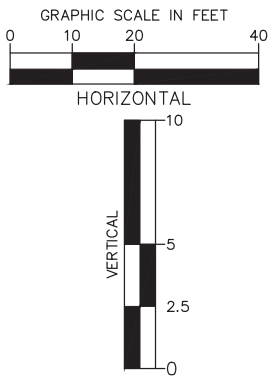
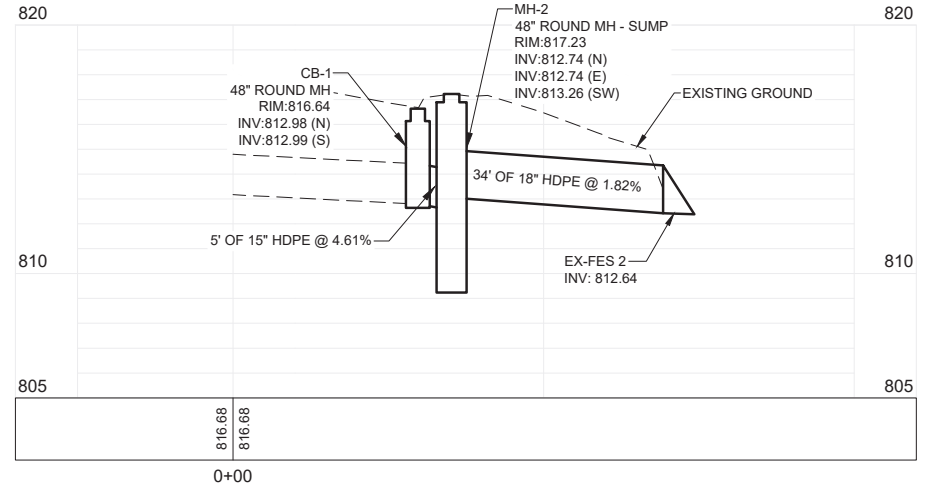

NO	DATE	BY	CHKD	APPR	REVISION
1	03/07/2023	AAK	AAK	PJS	WATERSHED COMMENTS

I hereby certify that this plan, specification, or report was prepared by me or under my direct supervision and that I am a duly Licensed Professional Engineer under the laws of the State of Minnesota.  
 Print Name: PATRICK J. SEJKORA  
 Date: 03/07/2023 License # 53713

CITY PROJECT NO. 23809  
 DRAWN BY MLS  
 DESIGNED BY MLS  
 CHECKED BY PJS  
 DATE: 02/14/23











CITY OF EDEN PRAIRIE  
 SUNNYBROOK CULVERT REPLACEMENT & ADA PEDESTRIAN RAMP PROJECT  
 STORM SEWER PROFILES

SHEET 9 OF 12

G:\Engineering\City-Active\Folders\23809 Sunnybrook Culvert Replacement\06 Design\CAD\Sunnybrook Culvert Replacement Plans.dwg

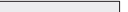
**LEGEND**

-  PROPERTY / ROW LINE
-  EXISTING CURB & GUTTER
-  EXISTING CONCRETE PAVEMENT
-  EXISTING SIGN
-  PROPOSED B618 CURB & GUTTER
-  PROPOSED SIGN
-  PROPOSED BITUMINOUS PAVEMENT
-  PROPOSED CONCRETE PAVEMENT
-  PROPOSED TRUNCATED DOMES

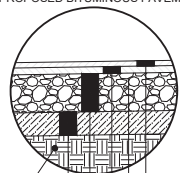
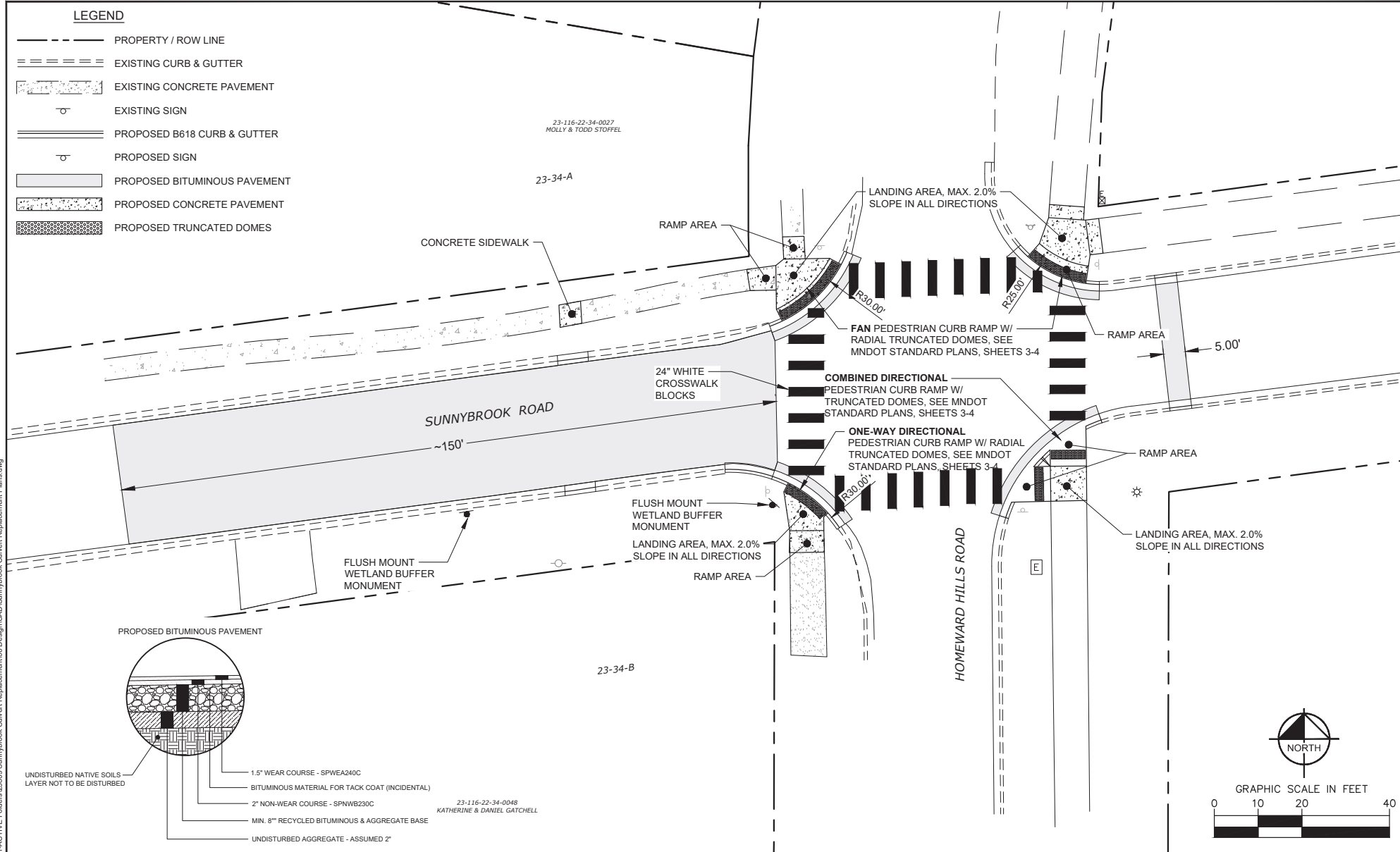

- UNDISTURBED NATIVE SOILS - LAYER NOT TO BE DISTURBED
- 1.5" WEAR COURSE - SPWEA240C
- BITUMINOUS MATERIAL FOR TACK COAT (INCIDENTAL)
- 2" NON-WEAR COURSE - SPNWB230C
- MIN. 8" RECYCLED BITUMINOUS & AGGREGATE BASE
- UNDISTURBED AGGREGATE - ASSUMED 2"

23-116-22-34-0048  
KATHERINE & DANIEL GATCHELL

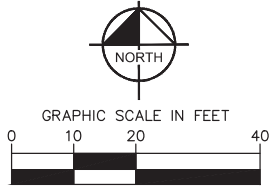

G:\Engineering\City\ACTIVE\EdenPrairie\Sunnybrook\_Culvert Replacement\08 Design\CAD\Sunnybrook\_Culvert Replacement Plans.dwg

NO	DATE	BY	CHKD	APPR	REVISION
1	03/07/2023	AAK	AAK	PJS	WATERSHED COMMENTS

I hereby certify that this plan, specification, or report was prepared by me or under my direct supervision and that I am a duly Licensed Professional Engineer under the laws of the State of Minnesota.  
 Print Name: PATRICK J. SEJKORA  
 Date: 03/07/2023 License # 53713

CITY PROJECT NO.  
23809











DRAWN BY  
MLS  
 DESIGNED BY  
MLS  
 CHECKED BY  
PJS  
 DATE: 02/14/23



CITY OF EDEN PRAIRIE  
 SUNNYBROOK CULVERT REPLACEMENT & ADA PEDESTRIAN RAMP PROJECT  
 PAVEMENT & ADA PEDESTRIAN RAMP PLAN

SHEET  
10  
OF  
12

**LEGEND**

-  PROPERTY / ROW LINE
-  EXISTING CURB & GUTTER
-  EXISTING CONCRETE PAVEMENT
-  EXISTING SIGN
-  PROPOSED B618 CURB & GUTTER
-  PROPOSED SIGN
-  PROPOSED BITUMINOUS PAVEMENT
-  PROPOSED CONCRETE PAVEMENT
-  PROPOSED TRUNCATED DOMES
-  TURF ESTABLISHMENT AREAS
-  FLOW DIRECTION

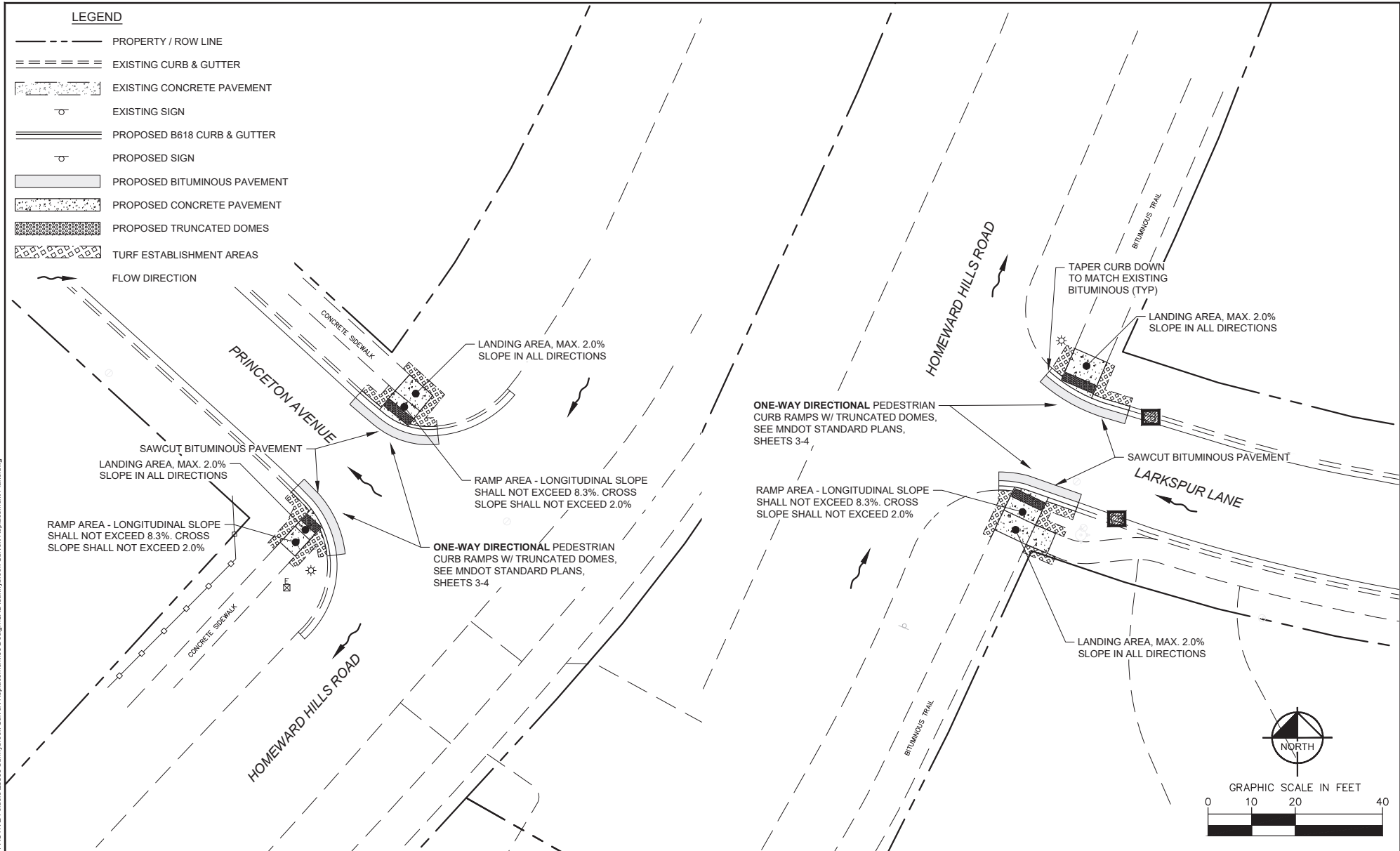

G:\Engineering\Civil-ACTIVE\Folders\23809 Sunnybrook Culvert Replacement\06 Design\CAD\Sunnybrook Culvert Replacement Plans.dwg

NO	DATE	BY	CHKD	APPR	REVISION
1	03/07/2023	AAK	AAK	PJS	WATERSHED COMMENTS

I hereby certify that this plan, specification, or report was prepared by me or under my direct supervision and that I am a duly Licensed Professional Engineer under the laws of the State of Minnesota.  
 Print Name: PATRICK J. SEJKORA  
 Date: 03/07/2023 License # 53713

CITY PROJECT NO.  
23809

DRAWN BY  
MLS  
 DESIGNED BY  
MLS  
 CHECKED BY  
PJS  
 DATE: 02/14/23



CITY OF EDEN PRAIRIE  
 SUNNYBROOK CULVERT REPLACEMENT & ADA PEDESTRIAN RAMP PROJECT  
 ADA PEDESTRIAN RAMP PLAN

SHEET  
11  
OF  
12

**LEGEND**

- PROPERTY / ROW LINE
- ═══ EXISTING CURB & GUTTER
- ▨ EXISTING CONCRETE PAVEMENT
- ⊕ EXISTING SIGN
- ═══ PROPOSED B618 CURB & GUTTER
- ⊕ PROPOSED SIGN
- PROPOSED BITUMINOUS PAVEMENT
- ▨ PROPOSED CONCRETE PAVEMENT
- ▨ PROPOSED TRUNCATED DOMES
- ▨ TURF ESTABLISHMENT AREAS
- FLOW DIRECTION

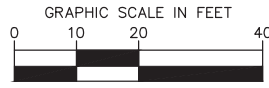
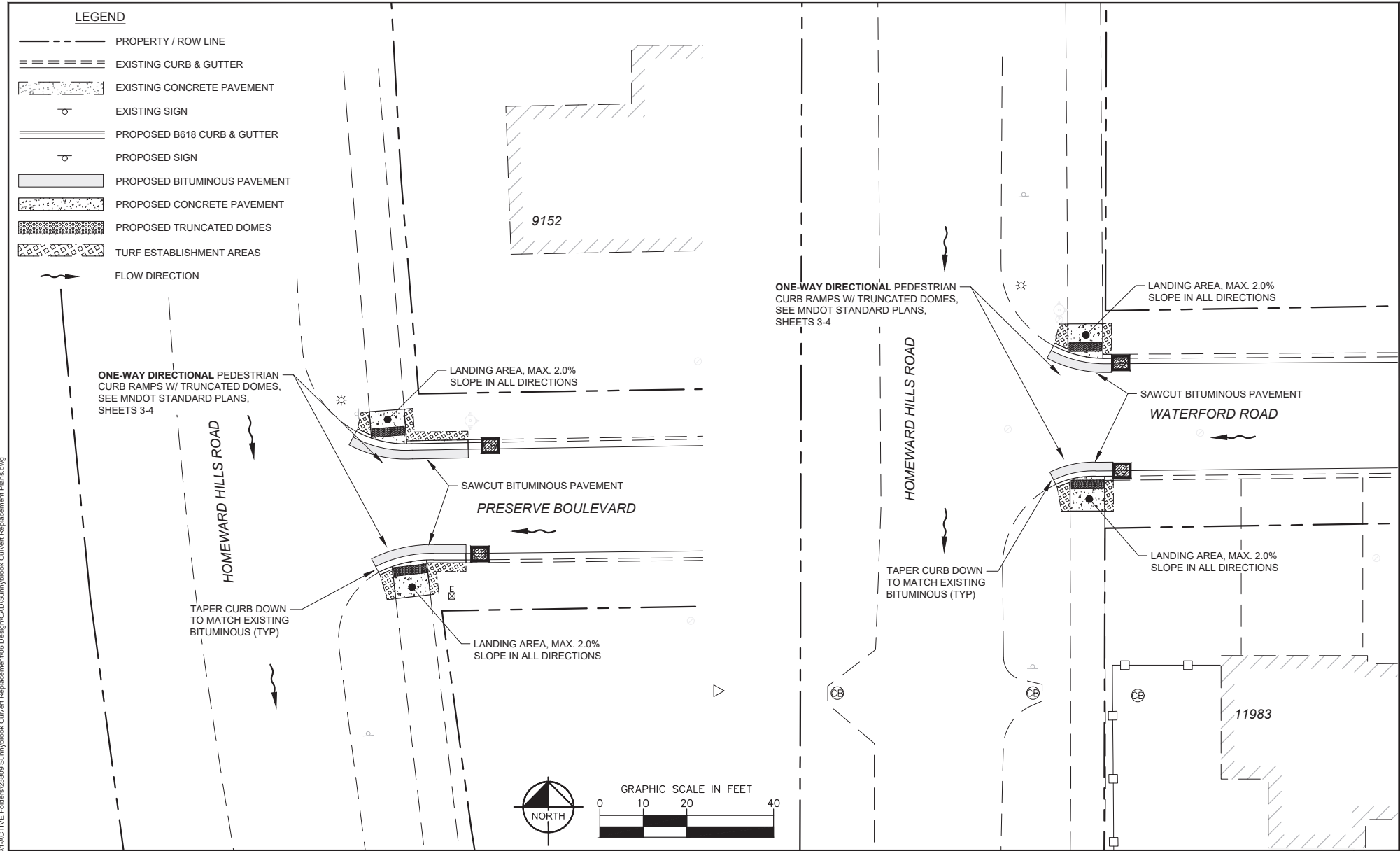

1	03/07/2023	AAK	AAK	PJS	WATERSHED COMMENTS
NO	DATE	BY	CKD	APPR	REVISION

I hereby certify that this plan, specification, or report was prepared by me or under my direct supervision and that I am a duly Licensed Professional Engineer under the laws of the State of Minnesota.  
 Print Name: PATRICK J. SEJKORA  
 Date: 03/07/2023 License # 53713

CITY PROJECT NO.  
23809

DRAWN BY  
 MLS  
 DESIGNED BY  
 MLS  
 CHECKED BY  
 PJS  
 DATE: 02/14/23



CITY OF EDEN PRAIRIE  
 SUNNYBROOK CULVERT REPLACEMENT & ADA PEDESTRIAN RAMP PROJECT  
 ADA PEDESTRIAN RAMP PLAN

SHEET  
 12  
 OF  
 12

G:\Engineering\Civil-Active\Foldas\28189 Sunnybrook Culvert Replacement\06 Design\CAD\Sunnybrook Culvert Replacement Plans.dwg